

KAWAI

KDP120 / KDP75 Owner's Manual

Important Information

Preparation

Basic Operation

Adjustments & Settings

Appendix

EN

Important Safety Instructions

SAVE THESE INSTRUCTIONS

INSTRUCTIONS PERTAINING TO A RISK OF FIRE, ELECTRIC SHOCK, OR INJURY TO PERSONS



CAUTION
RISK OF ELECTRIC SHOCK
DO NOT OPEN



WARNING

TO REDUCE THE RISK OF FIRE OR ELECTRIC SHOCK, DO NOT EXPOSE THIS PRODUCT TO RAIN OR MOISTURE.

AVIS : RISQUE DE CHOC ELECTRIQUE - NE PAS OUVRIR.

TO REDUCE THE RISK OF ELECTRIC SHOCK, DO NOT OPEN THE AC ADAPTOR.
NO USER-SERVICEABLE PARTS INSIDE. REFER SERVICING TO QUALIFIED SERVICE PERSONNEL.



The lightning flash with arrowhead symbol, within an equilateral triangle, is intended to alert the user to the presence of uninsulated "dangerous voltage" within the product's enclosure that may be of sufficient magnitude to constitute a risk of electric shock to persons.



The exclamation point within an equilateral triangle is intended to alert the user to the presence of important operating and maintenance (servicing) instructions in the literature accompanying the product.

Examples of Picture Symbols



denotes that care should be taken.
The example instructs the user to take care not to allow fingers to be trapped.



denotes a prohibited operation.
The example instructs that disassembly of the product is prohibited.





denotes an operation that should be carried out.
The example instructs the user to remove the power cord plug from the AC outlet.

Read all the instructions before using the product.

- 1) Read these instructions.
- 2) Keep these instructions.
- 3) Heed all warnings.
- 4) Follow all instructions.
- 5) Do not use this apparatus near water.
- 6) Clean only with dry cloth.
- 7) Do not block any ventilation openings. Install in accordance with the manufacturer's instructions.
- 8) Do not install near any heat sources such as radiators, heat registers, stoves, or other apparatus (including amplifiers) that produce heat.
- 9) Do not defeat the safety purpose of the polarized or grounding-type plug. A polarized plug has two blades with one wider than the other. A grounding type plug has two blades and a third grounding prong. The wide blade or the third prongs are provided for your safety. If the provided plug does not fit into your outlet, consult an electrician for replacement of the obsolete outlet.
- 10) Protect the power cord from being walked on or pinched particularly at plugs, convenience receptacles, and the point where they exit from the apparatus.
- 11) Only use attachments/accessories specified by the manufacturer.
- 12) Use only with the cart, stand, tripod, bracket, or table specified by the manufacturer, or sold with the apparatus. When a cart is used, use caution when moving the cart/apparatus combination to avoid injury from tip-over. 
- 13) Unplug this apparatus during lightning storms or when unused for long periods of time.
- 14) Refer all servicing to qualified service personnel. Servicing is required when the apparatus has been damaged in any way, such as power-supply cord or plug is damaged, liquid has been spilled or object have fallen into the apparatus, the apparatus has been exposed to rain or moisture, does not operate normally, or has been dropped.

Règles de sécurité (Supplémentaires pour le Canada)

CONSERVEZ CES INSTRUCTIONS

	CAUTION RISK OF ELECTRIC SHOCK DO NOT OPEN		AVERTISSEMENT POUR REDUIRE LES RISQUES D'INCENDIE OU D'ELECTROCUTION, PROTEGEZ CET APPAREIL DE LA PLUIE OU DE L'HUMIDITE.
---	---	---	--

AVIS : RISQUE DE CHOC ELECTRIQUE - NE PAS OUVRIR.

POUR REDUIRE LES RISQUES D'INCENDIE OU D'ELECTROCUTION, NE DEMONTEZ PAS LE COUVERCLE (OU L'ARRIERE). A L'INTERIEUR, AUCUNE PARTIE N'EST REPARABLE PAR L'UTILISATEUR. POUR LA MAINTENANCE, ADRESSEZ-VOUS A DU PERSONNEL QUALIFIE.





Le symbole de l'éclair avec une pointe de flèche à l'intérieur d'un triangle équilatéral met en garde l'utilisateur contre la présence de tension dangereuse, non isolée, à l'intérieur de l'appareil, dont l'amplitude peut être suffisante pour induire un risque d'électrocution d'une personne.



Le point d'exclamation à l'intérieur d'un triangle équilatéral alerte l'utilisateur de la présence de règles d'utilisation et d'entretien importantes dans la notice qui accompagne l'appareil.

Exemples de symboles graphiques

	Indique que des précautions doivent être prises. L'exemple indique à l'utilisateur qu'il doit faire attention à ne pas se faire coincer les doigts.
	Indique une manipulation interdite. L'exemple indique que le démontage de l'appareil est interdit.
	Indique qu'une manipulation doit être effectuée. L'exemple indique à l'utilisateur qu'il doit débrancher le câble d'alimentation de la prise secteur.



AVERTISSEMENT

Indique un risque potentiel qui peut entraîner la mort, ou de graves lésions, si l'appareil n'est pas manipulé correctement.

Faite attention de ne pas introduire un produit étranger à l'intérieur de l'appareil.

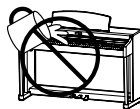

L'introduction d'eau, d'aiguilles ou d'épingles à cheveux, peut provoquer une panne ou un court-circuit. Ce produit doit être mis à l'abri des écoulements ou projections d'eau. Ne jamais placer sur le produit des objets contenant des liquides, tels que des vases ou autres récipients.

Ce produit n'est pas totalement déconnecté du circuit électrique lorsqu'il est mis hors tension par le bouton d'arrêt. Si l'appareil ne doit pas être utilisé pendant une longue période, débranchez le câble d'alimentation de la prise secteur.



- Si vous ne le faisiez pas la foudre pourrait provoquer un incendie.
- Si vous ne le faisiez pas, la surchauffe de l'appareil pourrait provoquer un incendie.

Il est recommandé de placer l'instrument à proximité de la prise de courant et de positionner le câble d'alimentation secteur de sorte qu'il puisse être débranché rapidement en cas d'urgence, le courant électrique étant toujours présent tant que la prise est branchée même si le bouton de mise en marche est en position Arrêt.

[Seuls les produits avec 3P fiche]

INSTRUCTIONS DE MISE À LA TERRE

Ce produit doit être mis à la terre. En cas de défaillance matérielle ou de panne, la mise à la terre fournit un chemin de moindre résistance au courant électrique afin de réduire le risque d'électrocution. Ce produit est équipé d'un câble avec un conducteur de protection et une fiche de mise à la terre. La fiche doit être branchée dans une prise appropriée correctement installée et mise à la terre conformément à tous les codes et règlements locaux.

DANGER - La connexion incorrecte du conducteur de protection peut présenter un risque d'électrocution.

Consultez un électricien ou un réparateur qualifié si vous avez des doutes en ce qui concerne la mise à la terre du produit. Ne modifiez pas la fiche fournie avec le produit – si elle n'est pas adaptée à la prise, faites installer une prise correcte par un électricien qualifié.



PRECAUTION

Indique un risque potentiel qui peut entraîner la détérioration, ou des dommages, pour l'appareil ou ses propriétés, si celui-ci n'est pas manipulé correctement.

Description de la l'emplacement de la référence (Le cas échéant):

Anglais phrase: The nameplate label is located on the underside of the instruments, as indicated below.

Français phrase: La référence commerciale est inscrite sur une étiquette en dessous de votre instrument, conformément à l'indication ci-dessous.

Votre piano doit être placé à un endroit tel que sa position n'altère pas sa propre ventilation. Gardez une distance minimum de 5 cm autour de l'instrument pour une aération suffisante.

WARNING - When using electric products, basic precautions should always be followed, including the following.



WARNING

Indicates a potential hazard that could result in death or serious injury if the product is handled incorrectly.

The product should be connected to an AC outlet of the specified voltage.

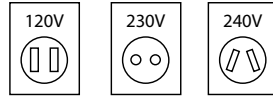

- If you are going to use an AC power cord, make sure that its has the correct plug shape and conforms to the specified power voltage.
- Failure to do so may result in fire.

Do not insert or disconnect the power cord plug with wet hands.



Doing so may cause electric shock.

Take care not to allow any foreign matter to enter the product.

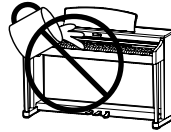

Entry of water, needles or hair pins may result in breakdown or short-circuit. The product shall not be exposed to dripping or splashing. No objects filled with liquids, such as vases, shall be placed on the product.

The chair must be used properly (it must be used only when playing the product).

- Do not play with it or stand on it.
- Only one person is allowed to sit on it.
- Do not sit on it when opening the lid.
- Re-tighten the bolts occasionally.

Doing so may cause the chair to fall over or your fingers to be trapped, resulting in injury.

When using the headphones, do not listen for long periods of time at high volume levels.

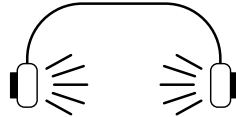

Doing so may result in hearing problems.

Do not lean against the keyboard.

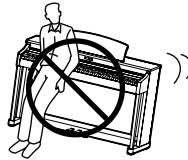

Doing so may cause the product to fall over, resulting in injury.

Do not disassemble, repair or modify the product.

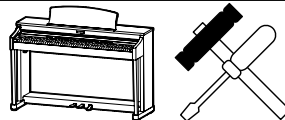

Doing so may result in product breakdown, electric shock or short-circuit.

When disconnecting the AC power cord's plug, always hold the plug and pull it to remove it.



- Pulling the AC power cord itself may damage the cord, causing a fire, electric shock or short-circuit.

The product is not completely disconnected from the power supply even when the power switch is turned off. If the product will not be used for a long time, unplug the AC power cord from the AC outlet.



- Failure to do so may cause fire in case of lightning.
- Failure to do so may over-heat the product, resulting in fire.

This product may be equipped with a polarized line plug (one blade wider than the other). This is a safety feature. If you are unable to insert the plug into the outlet, contact an electrician to replace your obsolete outlet. Do not defeat the safety purpose of the plug.

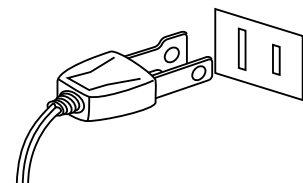

It is a good practice to have the instrument near the AC outlet and the power cord plug in a position so that it can readily be disconnected in an emergency because electricity is always charging while the plug is in the AC outlet even in a power switch off condition.



CAUTION

Indicates a potential hazard that could result in injury or damage to the product or other property if the product is handled incorrectly.

Do not use the product in the following areas.

- Areas, such as those near windows, where the product is exposed to direct sunlight
- Extremely hot areas, such as near a heater
- Extremely cold areas, such as outside
- Extremely humid areas
- Areas where a large amount of sand or dust is present
- Areas where the product is exposed to excessive vibrations

Using the product in such areas may result in product breakdown. Use the product only in moderate climates (not in tropical climates).

Use only the AC adaptor included with this instrument to power the instrument.

- Do not use other AC adaptors to power this instrument.
- Do not use the included AC adaptor or AC power cord to power other equipment.

When you close the keyboard cover, close it gently.



Closing it roughly may trap your fingers, resulting in injury.

Before connecting cords, make sure that the power to this product and other devices is turned OFF.

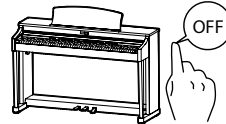

Failure to do so may cause breakdown of this product and other devices.

Do not drag the product on the floor. Take care not to drop the product.

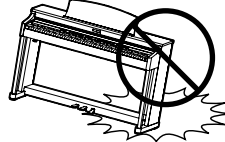

Please lift up the product when moving it. Please note that the product is heavy and must be carried by more than two persons. Dropping the product may result in breakdown.

Do not place the product near electrical appliances such as TVs and radios.

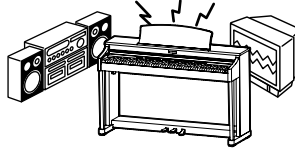

- Doing so may cause the product to generate noise.
- If the product generates noise, move the product sufficiently away from the electrical appliance or connect it to another AC outlet.

When connecting the AC power cord and other cords, take care not to get them tangled.



Failure to do so may damage them, resulting in fire, electric shock or short-circuit.

Do not wipe the product with benzene or thinner.



- Doing so may result in discoloration or deformation of the product.
- When cleaning the product, put a soft cloth in lukewarm water, squeeze it well, then wipe the product.

Do not stand on the product or exert excessive force.



- Doing so may cause the product to become deformed or fall over, resulting in breakdown or injury.

Do not place naked flame, such as lighted candles on the product.

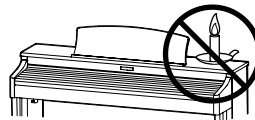

Doing so may cause the illumination to fall over, resulting in fire.

Ensure that the ventilation is not impeded by covering the ventilation openings with items, such as newspaper, table-cloths, curtains, etc.

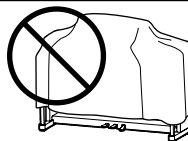

Failure to do so may over-heat the product, resulting in fire.

The product should be located so that its location or position does not interfere with its proper ventilation. Ensure a minimum distance of 5cm around the product for sufficient ventilation.

The product should be serviced by qualified service personnel when:

- The power supply cord or the plug has been damaged.
- Objects have fallen, or liquid has been spilled into the product.
- The product has been exposed to rain.
- The product does not appear to operate normally or exhibits a marked change in performance.
- The product has been dropped, or the enclosure damaged.

Notes on Repair

Should an abnormality occur in the product, immediately turn the power OFF, disconnect the power cord plug, and then contact the shop from which the product was purchased.

CAUTION:

To prevent electric shock, match wide blade of plug to wide slot, fully insert.

ATTENTION:

Pour éviter les chocs électriques, introduire la lame la plus large de la fiche dans la borne correspondante de la prise et pousser jusqu'au fond.



An information on Disposal for users

If your product is marked with this recycling symbol it means that, at the end of its life, you must dispose of it separately by taking it to an appropriate collection point. You should not mix it with general household waste. Disposing of this product correctly will prevent potential negative effects on the environment and human health which could otherwise arise due to inappropriate waste handling. For further details, please contact your local authority. (European Union only)

Instruction for AC power cord (U.K.)

IMPORTANT

THE WIRES IN THIS MAINS LEAD ARE COLOURED IN ACCORDANCE WITH THE FOLLOWING CODE.

- BLUE : NEUTRAL
- BROWN : LIVE

As the colours of the wires in the mains lead of this apparatus may not correspond with the coloured markings identifying the terminals in your plug, proceed as follows:

- The wire which is coloured BLUE must be connected to the terminal which is marked with the letter N or coloured BLACK.
 - The wire which is coloured BROWN must be connected to the terminal which is marked with the letter L or coloured RED.
- Do not plug either terminal of the power cord to the the ground od AC outlet on the wall.

Canadian Radio Interference Regulations

This instrument complies with the limits for a class B digital apparatus, pursuant to the Radio Interference Regulations, C.R.C., c. 1374.

FCC Information (U.S.A)

CAUTION : Changes or modifications not expressly approved by the party responsible for compliance could void the user's authority to operate the equipment.

NOTE : This equipment has been tested and found to comply with the limits for a Class B digital device, pursuant to Part 15 of the FCC Rules. These limits are designed to provide reasonable protection against harmful interference in a residential installation. This equipment generates, uses and can radiate radio frequency energy and, if not installed and used in accordance with the instructions, may cause harmful interference to radio communications. However, there is no guarantee that interference will not occur in a particular installation. If this equipment does cause harmful interference to radio or television reception, which can be determined by turning the equipment off and on, the user is encouraged to try to correct the interference by one or more of the following measures:

- Reorient or relocate the receiving antenna.
- Increase the separation between the equipment and receiver.
- Connect the equipment into an outlet on a circuit different from that to which the receiver is connected.
- Consult the dealer or an experienced radio/TV technician for help.

Declaration of Conformity

Products :	Electronic Piano
Model Number :	KDP120/KDP75
Responsible Party Name :	Kawai America Corporation
Address :	2055 East University Drive Rancho Dominguez, CA 90220
Telephone :	310-631-1771

This device complies with Part 15 of the FCC Rules.
 Operation is subject to the following two conditions:
 (1) this device may not cause harmful interference, and
 (2) this device must accept any interference received, including interference that may cause undesired operation.

The nameplate label is located on the underside of the instrument, as indicated below.

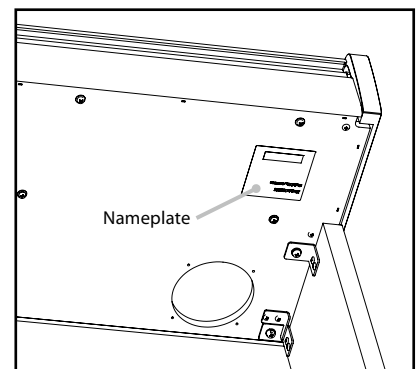

This applies only to products distributed by Kawai America Corporation.

Introduction

Thank you for purchasing this Kawai KDP120/KDP75 digital piano.

This owner's manual contains important information regarding the instrument's usage and operation. Please read all sections carefully, keeping this manual handy for future reference.

■ About this owner's manual

- This owner's manual provides information for customers to enjoy using this instrument immediately after purchase, and explanations about the various functions of this instrument.
- Display illustrations shown in this manual may differ from the actual displays of the product depending on its version.

■ Nameplate

The model name and serial number of the product are indicated on the nameplate label located on the underside of the instrument.

■ Cleaning

- Make sure to unplug the power cord before cleaning.
- Clean the product body with a dry, soft cloth.
- If the surface of the pedals becomes dirty, clean the pedals using a dry dish-washing sponge. Note that cleaning the gold pedals using a cloth may cause the pedals to become dull.
- Do not attempt to clean the pedals using rust-removing solvents, abrasives or files.
- Do not clean the product using benzine or thinner which may cause discoloring or deformation.

■ Intellectual property rights

- "Windows" is a registered trademark of Microsoft Corporation.
- The Bluetooth® word mark and logos are registered trademarks owned by the Bluetooth SIG, Inc. and any use of such marks by Kawai Musical Instruments Mfg. Co., Ltd. is under license.
- Other company names and product names mentioned or referenced herein are registered trademarks or trademarks of respective owners.
- Kawai Musical Instruments Mfg. Co., Ltd. shall have no liability for any acts in violation of the Copyright Act made by any users of this product.

Table of Contents

Important Information

Important Safety Instructions	2
Introduction	8
Table of Contents	9
Part Names and Functions	10

Preparation

Setting Up the Piano	11
----------------------------	----

Basic Operation

Operation Guide	12
Selecting Sounds	16
Using the Pedals	17
Dual Mode	18
Four Hands Mode	19
Metronome	20
Demo Songs	22
Concert Magic	23
Concert Magic demo modes	24
Concert Magic Mode	25
Concert Magic song arrangement types	26
Lesson Function	27
1. Selecting a lesson book/song	27
2. Listening to the selected lesson song	28
3. Practicing left and right-hand parts separately	29
Recorder	31
1. Recording a song	31
2. Playing back a song	32
3. Erasing recorded songs	32

Adjustments & Settings

Keyboard and Sound Settings	33
1. Damper Resonance	33
2. Reverb	34
3. Touch	34
4. Low Volume Balance	35
5. Tuning	35
6. Transpose	36
7. Brilliance	36
8. Virtual Technician (Smart Mode)	37
9. Spatial Headphone Sound	38
10. Phones Type	38
Auto Power Off	39
Bluetooth® MIDI (KDP120 only)	40
Information about Bluetooth® (KDP120 only)	41

Appendix

Connecting to Other Devices	42
USB MIDI (USB to Host connector)	43
Troubleshooting	44
Assembly Instructions	45
Demo Song List	49
Concert Magic Song List	49
Lesson Function Song Lists	50
Information about Adaptor Specifications	52
EU Declaration of Conformity	53
Specifications	54

Part Names and Functions

* The following diagram shows KDP120. Only the model name and input voltage are different in KDP75.

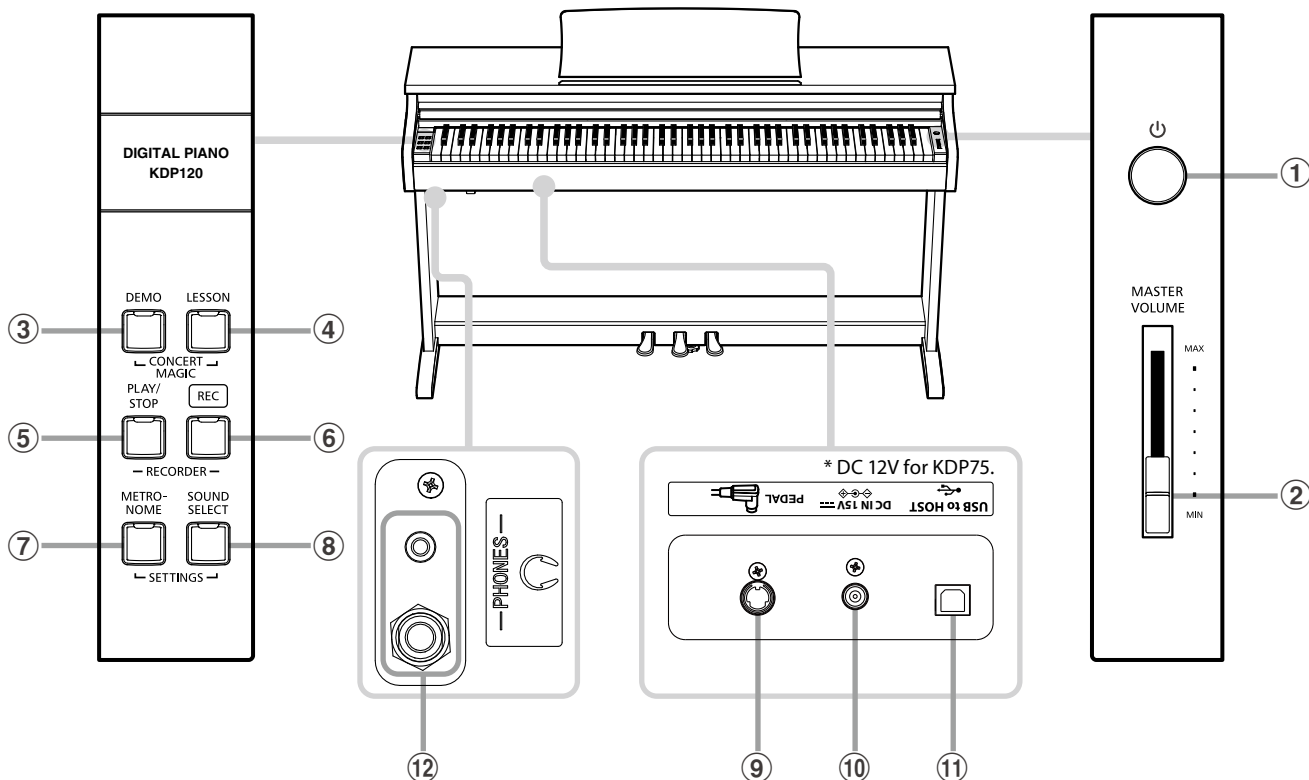

① POWER switch

This switch is used to turn the KDP120/KDP75 digital piano on/off. Be sure to turn off the instrument after playing.

② MASTER VOLUME slider

This slider controls the master volume level of the KDP120/KDP75 digital piano's built-in speakers or headphones, if connected.

③ DEMO button

This button is used to start/stop playback of the KDP120/KDP75 digital piano's built-in Demo songs.

④ LESSON button

This button is used to select the KDP120/KDP75 digital piano's built-in Lesson songs.

⑤ PLAY / STOP button

This button is used to start/stop the playback of Recorder songs stored in memory and KDP120/KDP75 digital piano's built-in Lessons songs.

⑥ REC button

This button is used to record performances to the KDP120/KDP75 digital piano's internal memory.

⑦ METRONOME button

This button is used to turn the metronome function on/off, and also to adjust its tempo, time signature, and volume settings.

⑧ SOUND SELECT button

This button is used to select the sound(s) that will be heard when the keys are pressed.

⑨ PEDAL connector

This connector is used to connect the KDP120/KDP75 digital piano's pedal board to the instrument.

⑩ DC IN jack

This jack is used to connect the AC adaptor.

⑪ USB to Host port

This port is use to connect the instrument to a computer using a USB "B to A" type cable in order to send and receive MIDI data.

⑫ PHONES jacks

These jacks are used to connect stereo headphones to the KDP120/KDP75 digital piano. Two pairs of headphones can be connected and used simultaneously.

■ Operation Guide

The separate Operation Guide provides a convenient overview of the KDP120/KDP75 digital piano's various button and keyboard controls. This sheet is also reprinted in the Appendix section of this owner's manual.

Setting Up the Piano

1. Connecting the power adaptor

Connect the AC power adaptor to the DC IN terminal located on the underside of the instrument, as indicated below.

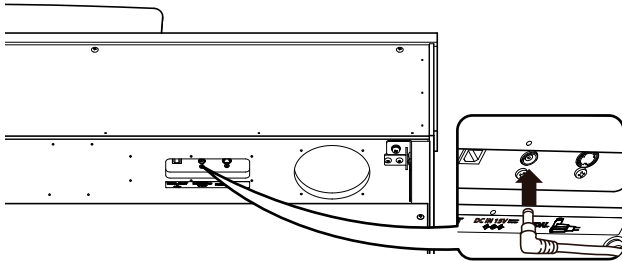

* DC 12V for KDP75.

2. Connecting the power adaptor to an outlet

Connect the AC power adaptor to an AC outlet.

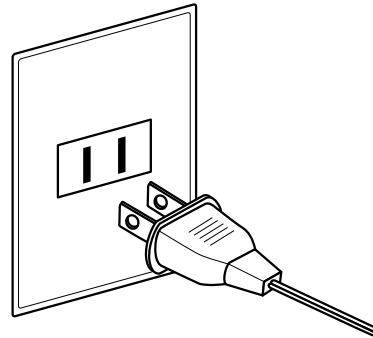

3. Turning on the power

Press the POWER switch, located on the right hand side of the keyboard.

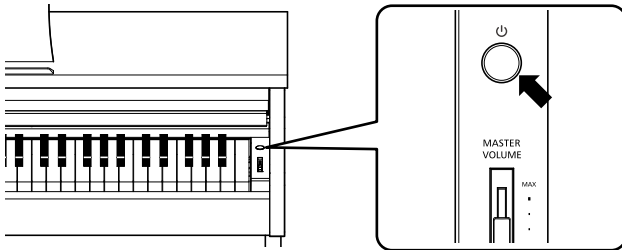

The LED indicator for the SOUND SELECT button will turn on and the Concert Grand sound will be selected automatically.

■ Using headphones

Use the jacks located beneath the keyboard on the left hand side, to connect stereo headphones to the KDP120/KDP75 digital piano.

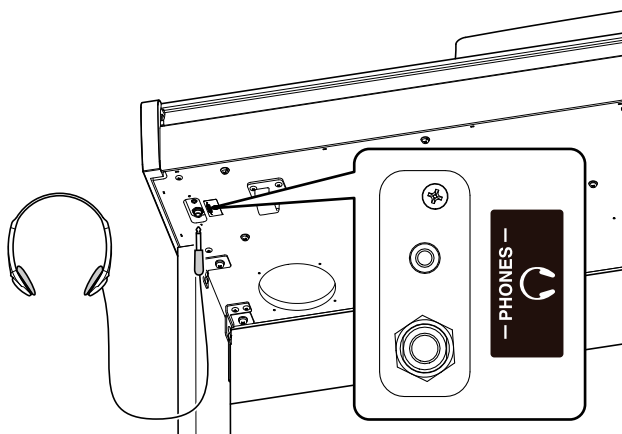

Up to two pairs of headphones can be connected and used simultaneously. When a pair of headphones is connected, sound will not be produced by the speakers.

4. Adjusting the volume

Move the MASTER VOLUME slider up and down to increase and decrease the volume level of the instrument's speakers, or headphones if connected.

Adjust the volume to a comfortable listening level - the middle is often a good starting point.

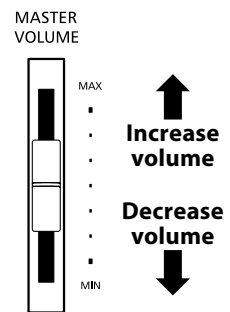

■ Adjusting the pedal support bolt

A pedal support bolt is attached at the base of the pedal board to aid stability when the pedals are pushed. Turn the bolt anti-clockwise until it makes contact with the floor and supports the pedals firmly.

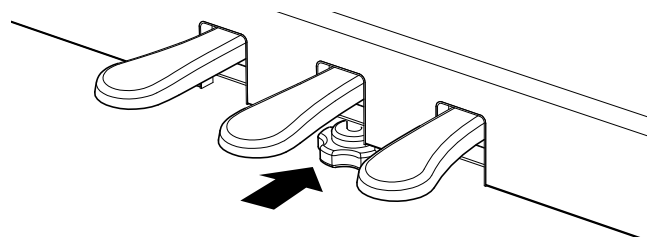

When moving the instrument, always adjust or remove the pedal support bolt, then readjust when the instrument is in its new position.

Operation Guide

In addition to the side panel buttons, the KDP120/KDP75 digital piano can also be controlled by pressing and holding a button, then pressing a key on the keyboard. This section explains the various functions for each panel button.

SOUND

SOUND SELECT



* Refer to page 18.

Dual

Dual Mode On

Dual Balance Reset

Dual Balance -

Dual Balance +

* Refer to page 33.

Damper Resonance
(For Concert Grand, Studio Grand, Mellow Grand, Modern Piano only)

Off

On

Small

Medium

Large

* Refer to page 34.

Touch

Off

Light

Normal

Heavy

* Refer to page 36.

Brilliance
(-10--+10)

Off

-

+

A ⁰	C ¹	D ¹	F ¹	G ¹	A ¹	C ²	D ²	F ²	G ²	A ²	C ³	D ³	F ³	G ³	A ³	C ⁴	D ⁴	F ⁴	G ⁴	A ⁴									
A0	B0	C1	D1	E1	F1	G1	A1	B1	C2	D2	E2	F2	G2	A2	B2	C3	D3	E3	F3	G3	A3	B3	C4	D4	E4	F4	G4	A4	B4
Concert Grand		Studio Grand		Mellow Grand		Modern Piano		Classic E.Piano		Modern E.Piano		Jazz Organ		Church Organ		Harpsichord		Vibraphone		String Ensemble		Slow Strings		Choir		New Age Pad		Atmosphere	

Sound Select

* Refer to page 16.

METRONOME

* Refer to page 20.

METRONOME



Metronome Time Signature

1/4

2/4

3/4

4/4

5/4

3/8

6/8

-

+

Metronome Volume

Grave..... 40

Largo..... 46

Leno..... 52

Larghetto..... 56

Adagio..... 60

Adagietto..... 66

Andante..... 72

Andantino..... 80

Maestoso..... 88

Moderato..... 96

Allegretto..... 108

Animato..... 120

Allegro..... 132

Vivace..... 160

A ⁰	C ¹	D ¹	F ¹	G ¹	A ¹	C ²	D ²	F ²	G ²	A ²	C ³	D ³	F ³	G ³	A ³	C ⁴	D ⁴	F ⁴	G ⁴	A ⁴									
A0	B0	C1	D1	E1	F1	G1	A1	B1	C2	D2	E2	F2	G2	A2	B2	C3	D3	E3	F3	G3	A3	B3	C4	D4	E4	F4	G4	A4	B4
Tempo -		Tempo +		1		2		3		4		5		6		7		8		9		0							

Metronome Tempo (3 digits)

Metronome Tempo (Musical Term)

CONCERT MAGIC

* Refer to page 23.

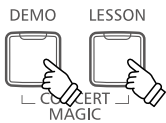

Song Select

I'm A Little Teapot 2

Old MacDonald Had A Farm Row, Row, Row Your Boat 5

Deck The Halls 10

We Wish You A Merry Christmas Joy To The World 12

Londonery Air 17

Auld Lang Syne 19

When The Saints Go Marching In 22

William Tell Overture 24

Fir Elise 26

Blue Danube Waltz 29

Waltz Of The Flowers 31

Pomp And Circumstance 34

Chopin's Polka 36

Funiculi Funicula 38

A ⁰	C ¹	D ¹	F ¹	G ¹	A ¹	C ²	D ²	F ²	G ²	A ²	C ³	D ³	F ³	G ³	A ³	C ⁴	D ⁴	F ⁴	G ⁴	A ⁴																											
A0	B0	C1	D1	E1	F1	G1	A1	B1	C2	D2	E2	F2	G2	A2	B2	C3	D3	E3	F3	G3	A3	B3	C4	D4	E4	F4	G4	A4	B4																		
1		3		4		6		8		9		11		13		15		16		18		20		21		23		25		27		28		30		32		33		35		37		39		40	

Song Select

* Refer to page 23.

* Refer to page 34.

Reverb

Off On

C5	D5	E5	F5	G5	A5	B5
Room	Lounge	Small Hall	Concert Hall	Live Hall	Cathedral	

Reverb

* Refer to page 37.

Virtual Technician

Clean Full Dark Rich Historical

C6	D6	E6	F6	G6	A6	B6
Normal	Noiseless	Deep Resonance	Light Resonance	Soft	Brilliant	

Virtual Technician

* Refer to page 38.

Spatial Headphone Sound

Off Forward Normal Wide

C7	D7	E7	F7	G7	A7	B7	C8
Normal	Open	Semi Open	Closed	Inner-ear	Canal		

Phones Type

* Refer to page 34.

* Refer to page 37.

* Refer to page 38.

C5	D5	E5	F5	G5	A5	B5	C6	D6	E6	F6	G6	A6	B6	C7	D7	E7	F7	G7	A7	B7	C8
Presto	Vivacissimo	Prestissimo																			
184	192	208																			

* Refer to page 24.

Concert Magic demo modes

Category Play
Random Play

C5	D5	E5	F5	G5	A5	B5	C6	D6	E6	F6	G6	A6	B6	C7	D7	E7	F7	G7	A7	B7	C8
----	----	----	----	----	----	----	----	----	----	----	----	----	----	----	----	----	----	----	----	----	----

Operation Guide

SETTINGS

METRO-NOME SOUND SELECT +

Transmit MIDI Program Change * Refer to PDF manual.

Multi-timbral Mode * Refer to PDF manual.

Bluetooth * Refer to page 40. (KDP120 only)

MIDI Channel * Refer to PDF manual.

Program Number (3 digits) * Refer to PDF manual.

Local Control * Refer to PDF manual.

MIDI Channel * Refer to PDF manual.

LESSON

* Refer to page 27.
Selecting a Lesson book and song

LESSON +

Book 1 Book 2 Book 3 Book 4 Book 5

Song Number (3 digits)

* Refer to page 28.
Listening to the song

DEMO LESSON

CONCERT MAGIC

PLAY/STOP REC

RECORDER

METRO-NOME SOUND SELECT

SETTINGS

* Refer to page 29.
Selecting the part to practice

METRO-NOME SOUND SELECT

SETTINGS

L

Press once:
Left-hand only

METRO-NOME SOUND SELECT

SETTINGS

R

Press twice:
Right-hand only

METRO-NOME SOUND SELECT

SETTINGS

L & R

Press 3 times:
Both Left and Right hands

* Refer to page 35.

* Refer to page 36.

Tuning			Transpose	
(427 Hz~453 Hz)			(-6~+5)	
440 Hz	-0.5 Hz	+0.5 Hz	Off	On
			-	+

F4	G4	A4	B4	C5	D5	E5	F5	G5	A5	B5	C6	D6	E6	F6	G6	A6	B6	C7	D7	E7	F7	G7	A7	B7	C8																													
Type5					Type4					Type3					Type2					Type1																																		
Off					1					2					3					4					5					6					7					8					9					0				

* Refer to page 35.

* Refer to page 35.

* Refer to page 39.

RECORDER

* Refer to page 31.
Record song

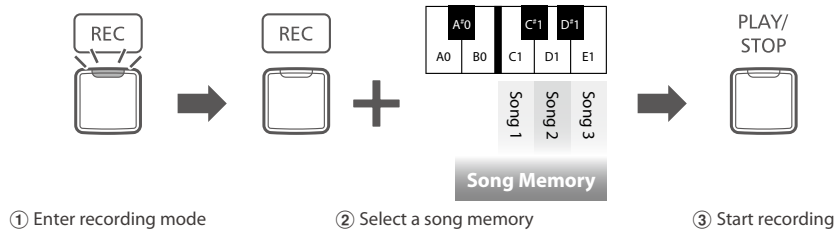

* Refer to page 32.
Play song

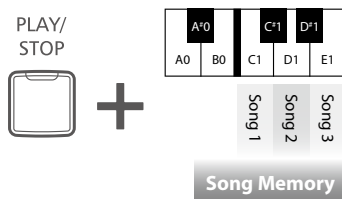

* Refer to page 32.
Erase all songs

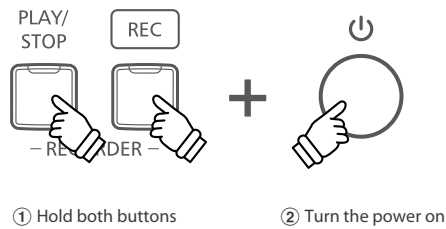

Selecting Sounds

The KDP120/KDP75 digital piano features 15 different instrument sounds, which can be selected in one of two ways. By default the "Concert Grand" sound will be selected automatically when the instrument is turned on.

Instrument Sounds

PIANO		E.PIANO / ORGAN		OTHERS	
1	Concert Grand	1	Classic E.Piano	1	Harpichord
2	Studio Grand	2	Modern E.Piano	2	Vibraphone
3	Mellow Grand	3	Jazz Organ	3	String Ensemble
4	Modern Piano	4	Church Organ	4	Slow Strings
				5	Choir
				6	New Age Pad
				7	Atmosphere

Selecting a sound: Method 1

Press the SOUND SELECT button repeatedly to cycle through the 15 available instrument sounds.

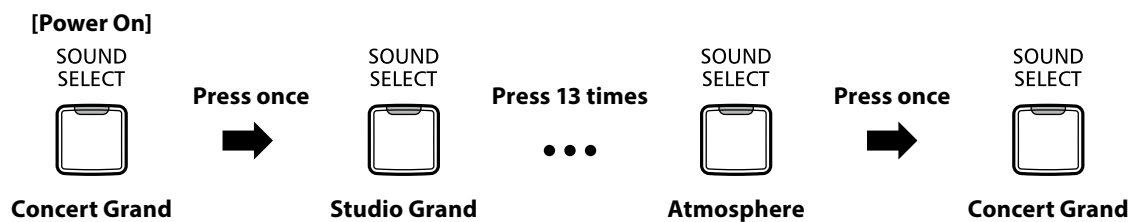

Selecting a sound: Method 2

Press and hold the SOUND SELECT button, then press one of the lowest 15 white keys to select the desired instrument sound.

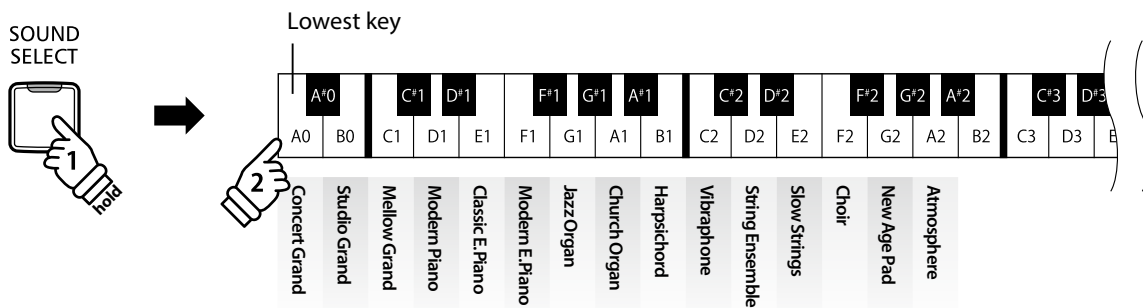

Using the Pedals

As with a grand piano, the KDP120/KDP75 digital piano features three pedals: sustain, sostenuto, and soft.

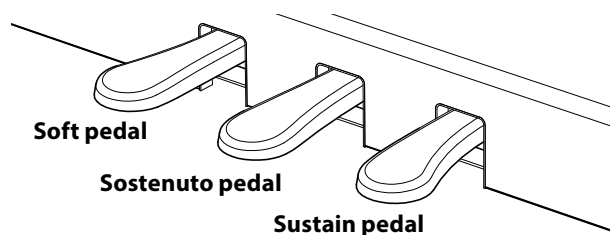

■ Sustain pedal (right pedal)

Depressing this pedal sustains the sound after one's hands have been lifted from the keyboard - greatly enriching the piano sound, while also assisting smooth "legato" passages.

The sustain pedal is capable of responding to half pedaling.

■ Sostenuto pedal (centre pedal)

Depressing this pedal after playing the keyboard and before releasing the keys, sustains the sound of only those notes that have been played. Any keys that are subsequently played after the sostenuto pedal is depressed will not be sustained.

■ Soft pedal (left pedal)

Depressing this pedal softens the sound, reducing its volume.

When the Jazz Organ sound is selected, the soft pedal is also used to alternate the speed of the rotary speaker simulation between "Slow" and "Fast" effect modes.

■ Grand Feel pedal system (KDP120 only)

The KDP120 digital piano features the new Grand Feel pedal system, which replicates the sustain, soft, and sostenuto pedal weighting of Kawai's SK-EX Concert Grand piano.

Dual Mode

The Dual playing mode allows two sounds to be layered together, creating a more complex sound. For example, a piano sound layered with strings, or a church organ combined with a choir, etc.

■ Enabling Dual Mode : Method 1

Operation Guide: SOUND (page 12~13)

Press and hold the SOUND SELECT button, then press two of the lowest 15 white keys simultaneously.

The sounds corresponding to the two keys will be layered together.

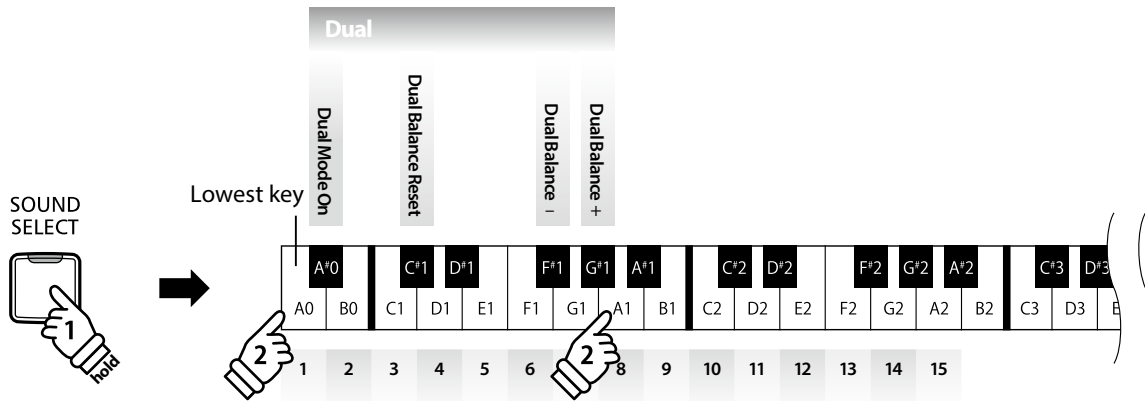

■ Enabling Dual Mode : Method 2

Operation Guide: SOUND (page 12~13)

Press and hold the SOUND SELECT button, then press the A#0 key.

While still holding the SOUND SELECT button, press two of the lowest 15 white keys in order.

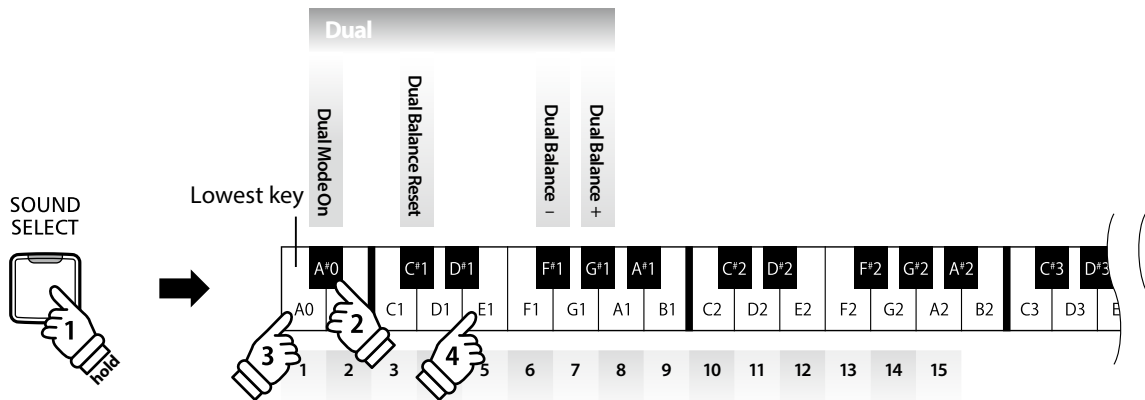

■ Adjusting the volume balance

Operation Guide: SOUND (page 12~13)

Press and hold the SOUND SELECT button, then press the F#1 or G#1 key repeatedly to decrease or increase the volume balance between the two sounds, or the C#1 key to reset the volume balance.

■ Exiting Dual Mode

Press the SOUND SELECT button.

The Concert Grand sound will be selected automatically and the instrument will return to normal operation.

Four Hands Mode

The Four Hands playing mode function divides the keyboard into two sections in a similar way to that of the Split keyboard mode. However, with Four Hands keyboard mode enabled, the octave/pitch of each section is automatically adjusted to create two separate 44-key instruments with the same playing range. Furthermore, the damper (right) pedal and soft (left) pedal act as separate damper pedals for the respective right and left sections, allowing two people to perform piano duets using a single instrument.

■ Enabling Four Hands Mode

Press and hold the LESSON button, then press the D#3 key, as shown in the illustration below.

The LED indicators for the LESSON button will start to flash, indicating that Four Hands Mode is enabled.

* The selected keyboard sound can still be changed when Four Hands Mode is enabled.

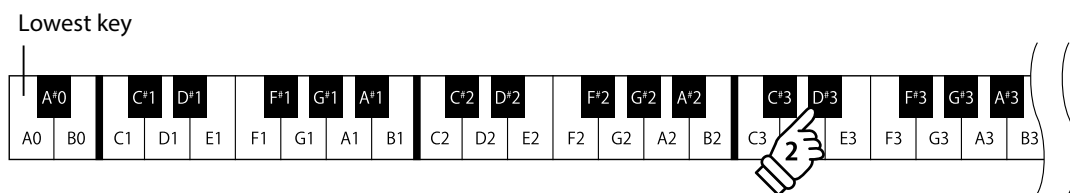
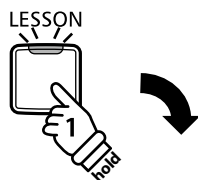

■ Exiting Four Hands Mode

Press the LESSON button.

The instrument will return to normal operation.

* With the Four Hands Mode activated, selecting a different sound will affect both the left and right sections.

* The Split Point for the Four Hands Mode is set to F4, and cannot be adjusted.

* The sostenuto pedal will affect the right section sound only.

Metronome

The Metronome function provides a steady beat to aid practicing the piano at a consistent tempo. The time signature, volume, and tempo of the metronome can be freely adjusted.

■ Turning the metronome on/off

Press the METRONOME button.

The metronome will start to count and the LED indicator for the METRONOME button will turn on, indicating that the metronome is in use.



* By default the metronome will count with a 1/4 beat at 120 bpm.

Press the METRONOME button again to stop the metronome.

■ Changing the metronome time signature

Operation Guide: METRONOME (page 12~13)

Press and hold the METRONOME button, then press one of the 7 lowest black keys, as shown in the illustration below.

* The metronome can be set to one of seven time signatures: 1/4, 2/4, 3/4, 4/4, 5/4, 3/8, and 6/8.

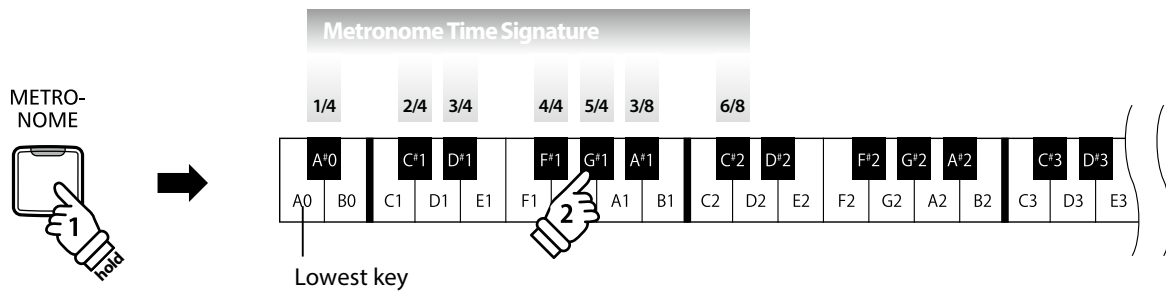

■ Adjusting the metronome volume

Operation Guide: METRONOME (page 12~13)

Press and hold the METRONOME button, then press the keys marked -/+ in the illustration below.

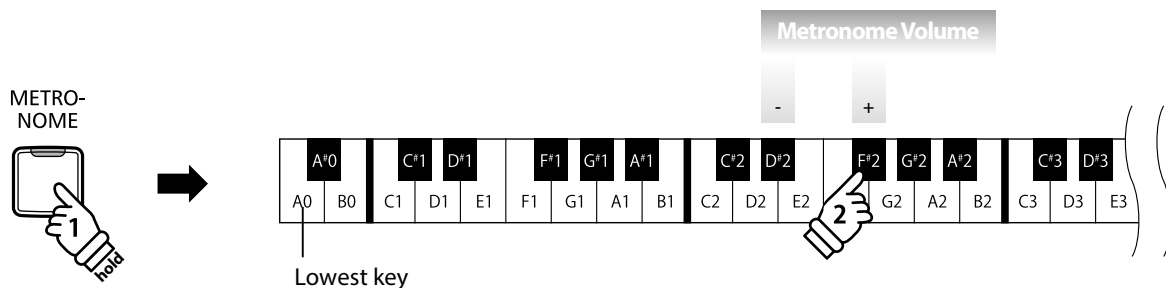

■ Adjusting the metronome tempo

Press and hold the METRONOME button, enter the desired tempo using the lowest 12 white keys marked below, then release the METRONOME button.

* The metronome tempo can be adjusted within the range of 10-300 bpm.

* The metronome tempo can be entered precisely, or decreased and increased gradually.

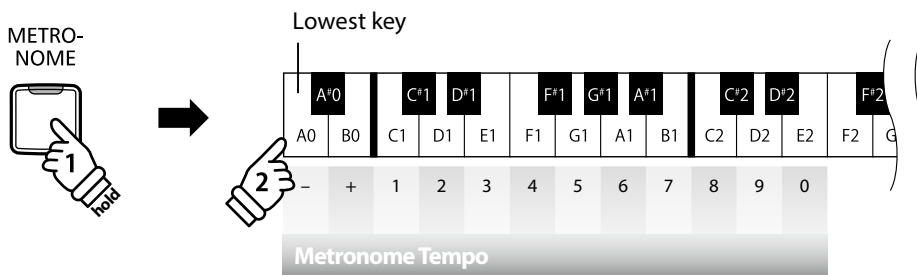

Method 1:

While pressing the METRONOME button, press keys 1, 5, and 0 to set the tempo to 150 bpm, or keys 8 and 5 to set the tempo to 85 bpm.

Method 2:

While pressing the METRONOME button, press the - / + keys repeatedly to gradually decrease or increase the tempo in 2 bpm increments.

It is also possible to conveniently set the metronome tempo to correspond with musical terms such as Allegro or Andante.

Method 3:

While pressing the METRONOME button, press keys C3~E5 to select the desired tempo.

	Key	Description	Tempo	
1	C3	Grave	Very slow	40
2	D3	Largo	Broadly	46
3	E3	Lento	Slowly	52
4	F3	Larghetto	Rather broadly	56
5	G3	Adagio	Slowly, with great expression	60
6	A3	Adagietto	Slightly faster than Adagio	66
7	B3	Andante	At a walking pace	72
8	C4	Andantino	Slightly faster than Andante	80
9	D4	Maestoso	Majestic and stately	88
10	E4	Moderato	At a moderate speed	96
11	F4	Allegretto	Moderately fast	108
12	G4	Animato	Lively and fast	120
13	A4	Allegro	Fast, quick, and bright	132
14	B4	Vivace	Active and quick	160
15	C5	Presto	Very, very fast	184
16	D5	Vivacissimo	Very fast and lively	192
17	E5	Prestissimo	Even faster than Presto	208

Demo Songs

The KDP120/KDP75 digital piano includes a selection of demonstration songs to introduce each internal sound.

■ Demo songs

Sound name	Song name	Composer
Concert Grand	La Campanella	Liszt
Studio Grand	Original	Kawai
Mellow Grand	Sonata No.30 Op.109	Beethoven
Modern Piano	Original	Kawai
Classic E.Piano	Original	
Modern E.Piano	Original	
Jazz Organ	Original	
Church Organ	Chorale Prelude "Wachet auf, ruft uns die Stimme."	Bach
Harpichord	French Suite No.6	Kawai
Vibraphone	Original	
String Ensemble	Le quattro stagioni: la "Primavera"	Vivaldi
Slow Strings	Original	Kawai
Choir	Londonderry Air	Irish folk song
New Age Pad	Original	Kawai
Atmosphere	Original	

* Kawai regret that sheet music for Kawai original demo songs is not available.

1. Playing the demo songs

Press the DEMO button.

The LED indicator for the DEMO button will start to flash, and the demo song for the Concert Grand sound will start to play.



* When the Concert Grand demo song has finished, another demo song will be selected at random. This process will continue until all of the demo songs have been played.

Press the DEMO button again to stop the demo.

2. Selecting a demo song

Operation Guide: SOUND (page 12~13)

While the demo is playing:

To listen to the demo song for a particular sound, press and hold the SOUND SELECT button, then press one of the lowest 15 white keys assigned to the desired sound.

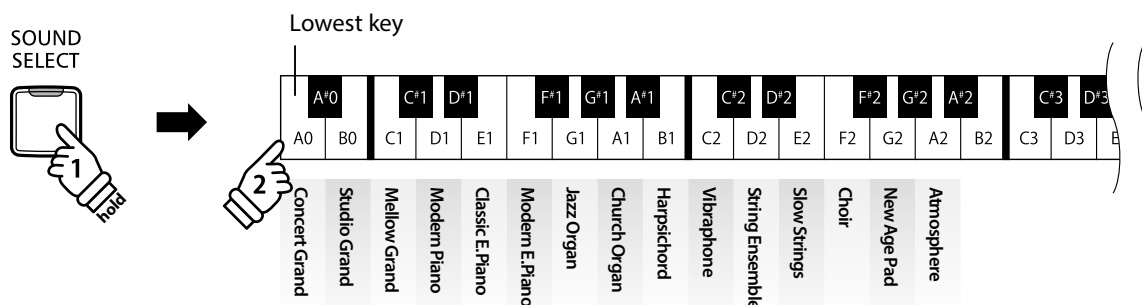

Alternatively, press the SOUND SELECT button to skip to the next demo song.

Concert Magic

The Concert Magic function allows complete beginners to enjoy playing the piano by simply selecting one of the 40 pre-programmed songs, then tapping the keyboard with a steady rhythm and tempo.

The Concert Magic songs are categorised by group and assigned to the lowest 40 keys of the keyboard. For a complete listing of available Concert Magic songs, please refer to page 49 of this owner's manual.

■ Selecting a Concert Magic song

Operation Guide: Concert Magic (page 12~13)

Press and hold the CONCERT MAGIC button (DEMO and LESSON buttons), then press the key assigned to the desired Concert Magic song.

The LED indicator for the CONCERT MAGIC button will turn on, indicating that Concert Magic playing mode is in use.

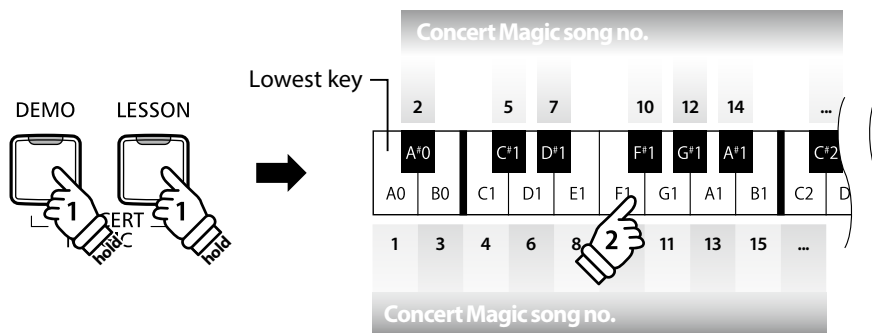

■ Listening to the selected Concert Magic song

Press the PLAY/STOP button.

The LED indicator for the PLAY/STOP button will turn on and the selected Concert Magic song will start to play.

- * The selected song will play repeatedly until it is stopped.
- * To listen to a different Concert Magic song simply repeat the above step.



Press either the PLAY/STOP or CONCERT MAGIC (DEMO and LESSON) button again to stop the song.

■ Performing the selected Concert Magic song

Press keys on the keyboard.

The song will advance with every key that is pressed.

Pressing the keys gently will produce a soft sound, while pressing heavily will produce a loud sound. Similarly, pressing the keys quickly will increase the tempo of the song, while pressing slowly will decrease the tempo.

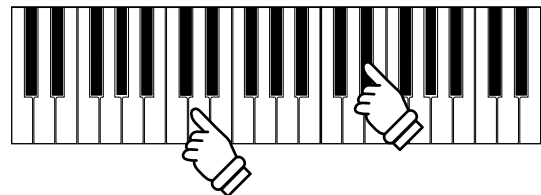

■ Exiting Concert Magic playing mode

Press the DEMO or LESSON button.

The LED indicator for the CONCERT MAGIC button will turn off and the instrument will return to normal operation.

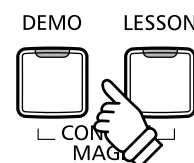

Concert Magic demo modes

The Concert Magic demo modes allow the Concert Magic songs to be listened to in one of three ways: All Play, Category Play, and Random Play

All Play

Press the CONCERT MAGIC button (DEMO and LESSON buttons), then press the PLAY/STOP button.

The LED indicator for the PLAY/STOP button will turn on and the Concert Magic songs will start to play in numerical order.

Press either the CONCERT MAGIC or PLAY/STOP button again to stop song playback.

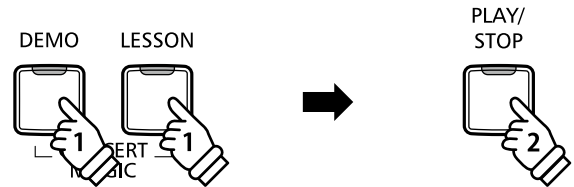

Category Play

Operation Guide: Concert Magic (page 12~13)

Press and hold the CONCERT MAGIC button (DEMO and LESSON buttons), then press the key assigned to the desired Concert Magic song.

While still holding the CONCERT MAGIC button, press the G#7 key.

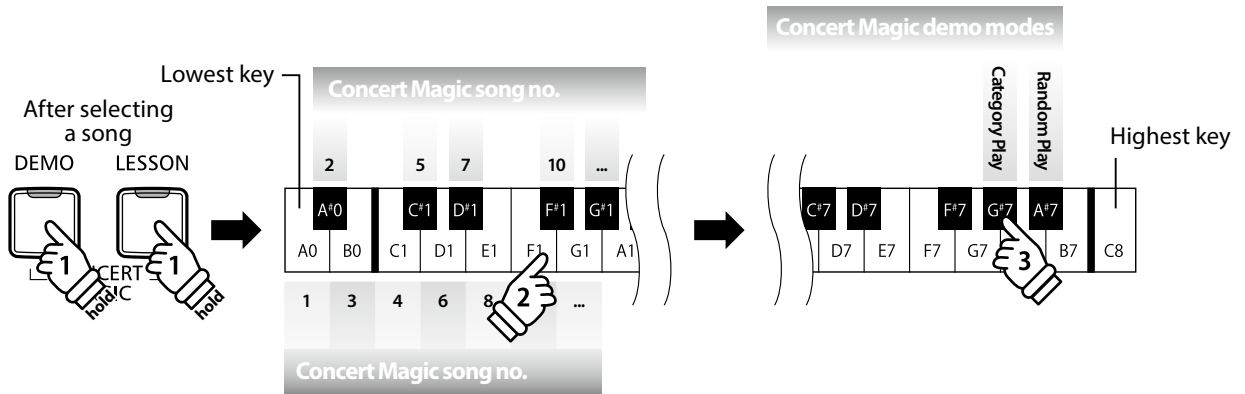

The selected Concert Magic song will start to play.

* When the selected song finishes, the next song in the same category will start to play automatically.

Random Play

Operation Guide: Concert Magic (page 12~13)

Press the CONCERT MAGIC button (DEMO and LESSON buttons) and then press the A#7 key.

The KDP120/KDP75 digital piano will play back the first Concert Magic song, followed by the remaining 39 Concert Magic songs in random order.

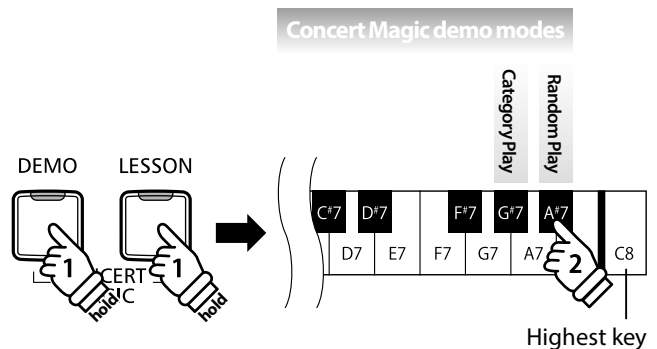

Concert Magic Mode

The Concert Magic Mode setting changes the Concert Magic playing mode, allowing all Concert Magic songs to be played by simply tapping any key with a constant steady beat, regardless of the song arrangement type.

■ Concert Magic Mode

Concert Magic Mode	Description	Pedal
Normal	Concert Magic songs will be performed according to their arrangement type.	Soft
Steady Beat	All Concert Magic songs will be performed by tapping the key with a constant beat.	Sostenuto

■ Changing the Concert Magic Mode

Press and hold the CONCERT MAGIC button (DEMO and LESSON buttons), then press the pedal assigned to the desired Concert Magic Mode.

To select Normal mode, press and hold the CONCERT MAGIC button, then depress the Soft pedal.

To select Steady Beat mode, press and hold the CONCERT MAGIC button, then depress the Sostenuto pedal.

The selected Concert Magic Mode type will be applied immediately.

* When the instrument is turned on, the Concert Magic Mode setting will return to the default type of "Normal".

Concert Magic song arrangement types

Concert Magic songs are divided into three different arrangement types: Easy Beat (EB), Melody Play (MP), and Skillful (SK). Each arrangement type requires a different level of skill to be performed correctly.

Easy Beat

EB

These are the easiest songs to play. To perform them, simply tap out a constant, steady beat on any key of the keyboard. For example, when playing the piece "Für Elise", a constant, steady rhythm should to be maintained throughout the song.

Key on: X

Melody Play

MP

These songs are also relatively easy to play, especially if they are familiar to the player. To perform them, tap out the rhythm of the melody on any key of the keyboard. Singing along as the rhythm is tapped can be helpful. For example, when playing the piece "Twinkle, Twinkle, Little Star", the rhythm of the melody should be played.

* When performing fast Concert Magic songs, it may be easier to press different keys with two alternating fingers in order to achieve greater speed.

Key on: X X X X X X X X X X X X X X X

Skillful

SK

These songs range in difficulty from moderately difficult to difficult. To perform them, tap out the rhythm of both the melody and the accompaniment notes on any key of the keyboard.

For example, when playing the piece "Waltz of the Flowers", the rhythm of both the melody and the accompaniment should be played.

Key on: X X X X X X X X X X X X X

Lesson Function

The Lesson function allows budding pianists to practice the piano using a selection of built-in song books. The left and right hand parts for each piece can be practiced separately, while adjusting the tempo allows difficult passages to be perfected.

For a complete listing of available Lesson Function songs, please refer to page 50 of this owner's manual.

■ Built-in lesson function song books

	US, Canada, Australasia	Rest of the World
Book 1	Alfred's Basic Piano Library Lesson Book Level 1A	Beyer 106 (Vorschule im Klavierspiel, Opus 101)
Book 2	Alfred's Basic Piano Library Lesson Book Level 1B	Burgmüller 25 (25 Etudes Faciles, Opus 100)
Book 3	Beyer 106 (Vorschule im Klavierspiel, Opus 101)	Czerny 30 (Etudes de Mécanisme, Opus 849)
Book 4	Burgmüller 25 (25 Etudes Faciles, Opus 100)	Alfred's Basic Piano Library Lesson Book Level 1A
Book 5	Czerny 30 (Etudes de Mécanisme, Opus 849)	Alfred's Basic Piano Library Lesson Book Level 1B

* Lesson books sold separately - please refer to page 51 of this owner's manual for more information.

1 Selecting a lesson book/song

1. Entering lesson mode

Press the LESSON button.

The LED indicator for the LESSON button will turn on, indicating that lesson mode is enabled, and the Concert Grand sound will be selected automatically.

LESSON



2. Selecting a lesson book

Operation Guide: LESSON (page 14)

While holding down the LESSON button, press the black key assigned to the desired lesson book.

3. Selecting a lesson song

Operation Guide: LESSON (page 14)

While holding down the LESSON button, enter the piece number by pressing the corresponding white keys in sequence (e.g. to select piece no.25, press D1 followed by G1). Then, release the LESSON button.

■ Selecting the Beyer variation

The Beyer lesson book includes 106 exercises. Exercise no.1 consists of 12 variations, while exercise no.2 consists of 8 variations.

To select the variation for the no.1 and no.2 exercises, first press and hold the LESSON button and press the corresponding black key to select the Beyer lesson book.

While holding down the LESSON button, press the C1 or D1 key to select the no.1 or no.2 exercise, then finally press the B0 key (+) multiple times to select the desired variation.

Listing of Beyer's pieces

No. 1 Theme

1-1 to 1-12 Variations

No. 2 Theme

2-1 to 2-8 Variations

No. 3 Theme

No. 4 Theme

↓ Theme

No. 106 Theme

2 Listening to the selected lesson song

This page will explain how to play and stop the selected lesson song, and adjust the tempo.

■ Playing the lesson song

After selecting a lesson book and song:

Press the PLAY/STOP button.

The LED indicator for the PLAY/STOP button will turn on, and a one bar count-in will be heard before the song starts to play.

While the lesson song is playing, press the METRONOME button to turn the metronome on/off.

* The metronome time signature and tempo will automatically be set to that of the currently selected lesson song.

PLAY/
STOP



METRO-
NOME



■ Adjusting tempo of the lesson song

Operation Guide: METRONOME (page 12~13)

While the lesson song is playing:

Press and hold the METRONOME button, enter the desired tempo using the lowest 12 white keys marked below, then release the METRONOME button.

* The lesson song tempo can be adjusted within the range of 10-300 bpm.

* The lesson song tempo can be entered precisely, or decreased and increased gradually.

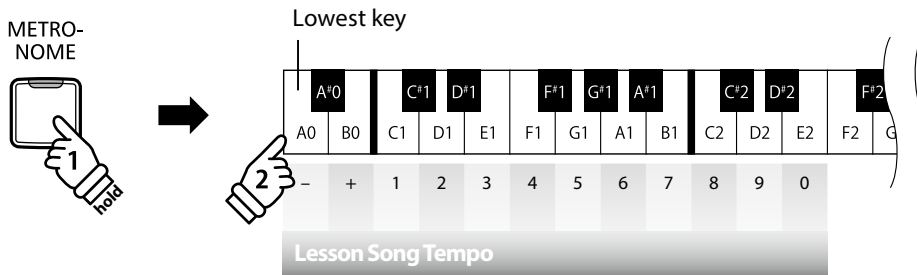

Method 1:

While pressing the METRONOME button, press keys 1, 5, and 0 to set the tempo to 150 bpm, or keys 8 and 5 to set the tempo to 85 bpm.

Method 2:

While pressing the METRONOME button, press the - / + keys repeatedly to gradually decrease or increase the tempo in 2 bpm increments.

■ Stopping the lesson song

While the lesson song is playing:

Press the PLAY/STOP button again to stop the lesson song.

The LED indicator for the PLAY/STOP button will turn off.

PLAY/
STOP



3 Practicing left and right-hand parts separately

This page will explain how to mute/activate the left and right-hand parts of the selected lesson song, allowing each part to be practiced separately.

The LED indicators for the METRONOME and SOUND SELECT buttons are used to indicate which part (left or right-hand) of the selected lesson song is muted/active.

METRONOME button LED	SOUND SELECT button LED	Lesson song playback
On	On	Left and Right-hand parts (default playing mode)
On	Off	Left-hand part only
Off	On	Right-hand part only

■ Muting/activating lesson song parts 1

After selecting a lesson book and song:

Press the SOUND SELECT button.

The LED indicator for the SOUND SELECT button will turn off (the LED indicator for the METRONOME button will remain turned on), indicating that only the left-hand part of the lesson song is active (i.e. the right-hand part will be muted).

Press once:
Left-hand only

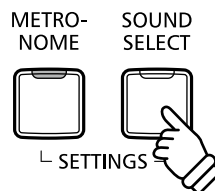

Press the SOUND SELECT button again.

The LED indicator for the SOUND SELECT button will turn on and the LED indicator for the METRONOME button will turn off, indicating that only the right-hand part of the lesson song is active (i.e. the left-hand part will be muted).

Press twice:
Right-hand only

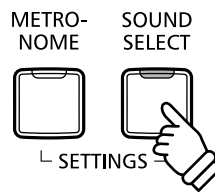

Press the SOUND SELECT button once again.

The LED indicator for the SOUND SELECT button will remain turned on and the LED indicator for the METRONOME button will also turn on, indicating that both the left and right-hand parts of the lesson song are active.

Press 3 times:
Left and Right-hand

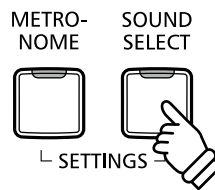

■ Muting/activating lesson song parts 2

Select a part directly. While holding down the LESSON button, press the part button you want to replay.

Press and hold the METRONOME and SOUND SELECT buttons simultaneously, both the left and right parts will return to playback.

To restore the normal replay, exit the lesson mode and then enter the lesson mode again.

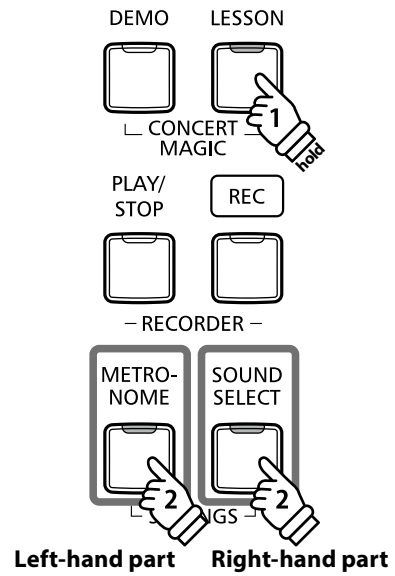

■ Exiting lesson mode

Press the LESSON button.

The LED indicator for the LESSON button will turn off, and the instrument will return to normal operation.



Recorder

The KDP120/KDP75 digital piano allows up to 3 different songs to be recorded, stored in internal memory, and played back at the touch of a button.

1 Recording a song

1. Entering song recorder mode

Press the REC button.

The LED indicator for the REC button will start to flash, to indicate that the piano is in recording standby mode.

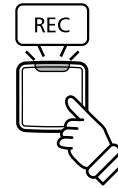

2. Selecting a song memory

Operation Guide: RECORDER (page 15)

Press and hold the REC button, then press the C1, D1 or E1 key to select the desired song memory.

* Selecting a song memory that has already been used to record a song will automatically erase the previously recorded song.

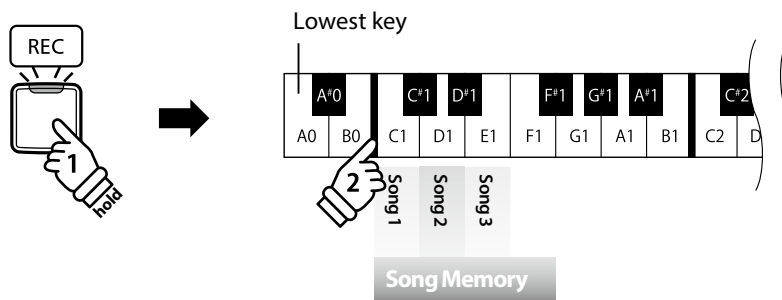

3. Starting the song recorder

Press a key on the keyboard.

The LED indicators for the REC and PLAY/STOP buttons will turn on, and recording will start.

* Recording can also be started by pressing the PLAY/STOP button, allowing a rest period or empty bar to be inserted at the beginning of the song.

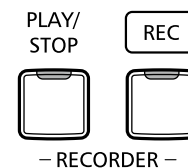

4. Stopping the song recorder

Press the PLAY/STOP button.

The LED indicators for the PLAY/STOP and REC buttons will turn off.

* The maximum recording capacity is approximately 10,000 notes, with button and pedal presses also counted as one note. If the maximum recording capacity is reached during recording, the recorder will stop automatically.

* Recorder songs will remain in memory after the power is turned off.

2 Playing back a song

1. Playing the recorded song

Press the PLAY/STOP button.

The LED indicator for the PLAY/STOP button will turn on, and the recorded song will start to play.



2. Playing a song stored in another memory

Operation Guide: RECORDER (page 15)

Press and hold the PLAY/STOP button, then press the C1, D1 or E1 key to play the desired song memory.

* The selected song will start to play when the PLAY/STOP button is released.

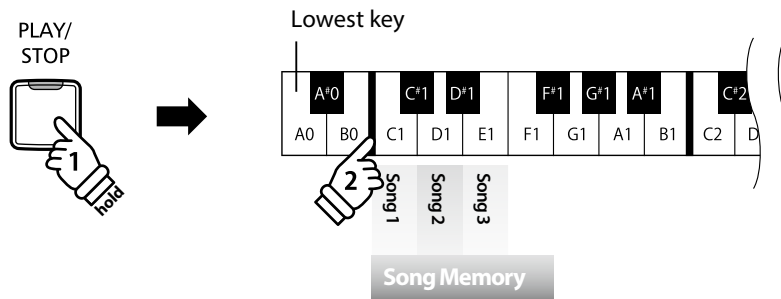

3 Erasing recorded songs



Warning: This process will erase all three songs stored in internal memory, and cannot be undone.

Erasing the recorder songs

Press and hold the PLAY/STOP and REC buttons simultaneously, then turn the instrument's power on.

All recorder songs stored in memory will be erased.

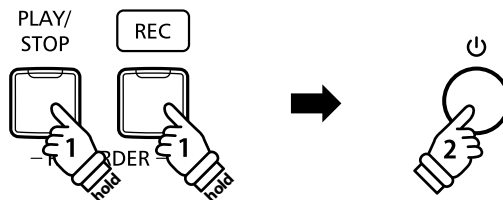

Keyboard and Sound Settings

The KDP120/KDP75's keyboard and sound settings allow various aspects of the instrument to be adjusted.

■ Keyboard and Sound Settings

Setting name	Explanation	Default setting
Damper Resonance	Adjust the resonance that is heard when depressing the damper pedal.	Medium
Reverb	Change the type of reverberation added to the sound.	On
Touch	Change the touch sensitivity of the keyboard.	Normal
Low Volume Balance	Change the difference in volume between pianissimo and fortissimo playing.	Type3
Tuning	Increase or decrease the pitch of the keyboard in 0.5 Hz steps.	440.0Hz
Transpose	Increase or decrease the pitch of the keyboard in semi-tone steps.	0
Brilliance	Adjust the brightness of the sound.	0
Virtual Technician	Select the tuning from 10 preset styles.	Off
Spatial Headphone Sound	Select the desired Spatial Headphone Sound mode.	Normal
Phones Type	Select the type of headphones to be used with the instrument.	Normal

1 Damper Resonance

Depressing the sustain pedal of an acoustic piano raises all dampers, allowing the strings to vibrate freely. When a note or chord is played on the piano with the sustain pedal depressed, not only will the strings of the notes played vibrate, but also the strings of other notes, vibrating in sympathetic resonance.

The KDP120/KDP75 digital piano recreates this phenomenon, with the Damper Resonance setting allowing the volume of this resonance to be changed.

■ Damper Resonance

Sounds affected by Damper Resonance			
Concert Grand	Studio Grand	Mellow Grand	Modern Piano

■ Damper Resonance type

Damper Resonance type	Description	Key
Off	Disables the damper resonance effect.	C#2
On	(Re)Enables the damper resonance effect.	D#2
Small	Piano sounds produce a small amount of damper resonance.	F#2
Medium (default)	Piano sounds produce a medium amount of damper resonance.	G#2
Large	Piano sounds produce a large amount of damper resonance.	A#2

■ Changing the Damper Resonance type

Operation Guide: SOUND (page 12~13)

Press and hold the SOUND SELECT button, then press the key assigned to the desired Damper Resonance type.

* To disable/enable the damper resonance effect, press the key assigned to the off/on function.

* If the damper resonance effect is disabled, it will be turned on automatically upon selecting a damper resonance type.

2 Reverb

Adjust the type and amount of reverb applied to the current sound, in order to simulate various different virtual environments. The most suitable reverb type is applied automatically when selecting each sound, however it is also possible to select a different reverb type manually if desired.

■ Reverb type

Reverb type	Description	Key
Off	Disables the reverb effect.	C#5
On	(Re)Enables the reverb effect.	D#5
Room	Simulates the ambience of a small rehearsal room.	C5
Lounge	Simulates the ambience of piano lounge.	D5
Small Hall	Simulates the ambience of a small hall.	E5
Concert Hall	Simulates the ambience of a concert hall or theater.	F5
Live Hall	Simulates the ambience of a live hall or stage.	G5
Cathedral	Simulates the ambience of a large cathedral.	A5

■ Changing the Reverb type

Operation Guide: SOUND (page 12~13)

Press and hold the SOUND SELECT button, then press the key assigned to the desired Reverb type.

* To disable/enable the reverb effect, press the key assigned to the "off/on" function.

* If the reverb effect is disabled, it will be turned on automatically upon selecting a reverb type.

3 Touch

As with an acoustic piano, the KDP120/KDP75 digital piano produces a louder sound when the keys are struck with force, and a softer sound when the keys are played gently. The volume and tonal character change in relation to the strength and speed of playing - on a digital piano this system is referred to as "touch sensitivity".

The Touch setting allows the touch sensitivity of the keyboard to be conveniently adjusted. There are four different preset touch settings available.

■ Touch type

Touch type	Description	Key
Off	A constant volume is produced regardless of how hard the keys are struck. This setting is recommended for sounds that have a fixed dynamic range such as organ and harpsichord.	C#3
Light	A louder volume is produced even when playing with a soft touch. This setting is recommended for children and organ players, or for those still developing finger strength.	F#3
Normal (default)	Reproduces the standard touch sensitivity of an acoustic piano.	G#3
Heavy	Requires a heavier touch to produce a loud volume. This setting is recommended to those with stronger fingers.	A#3

■ Changing the Touch type

Operation Guide: SOUND (page 12~13)

Press and hold the SOUND SELECT button, then press the key assigned to the desired touch type.

4 Low Volume Balance

The Low Volume Balance setting reduces the difference in volume between pianissimo and fortissimo touches, allowing the piano to continue to be played at low volume without the sound of pianissimo notes being lost.

■ Low Volume Balance type

Low Volume Balance type	Description	Key
Off	Low Volume Balance adjustment is not applied.	F4
Type1	When playing at low volume, a small amount of Low Volume Balance adjustment will be applied.	G4
Type2	The amount of Low Volume Balance adjustment applied when playing at low volume will gradually increase.	A4
Type3 (default)		B4
Type4		C5
Type5	When playing at low volume, a large amount of Low Volume Balance adjustment will be applied.	D5

■ Changing the Low Volume Balance type

Operation Guide: SETTINGS (page 14~15)

Press and hold the METRONOME and SOUND SELECT buttons, then press the key assigned to the desired Low Volume Balance type.

5 Tuning

The Tuning setting allows the overall pitch of the KDP120/KDP75 digital piano to be raised and lowered in 0.5 Hz steps, and may therefore prove useful when playing with other instruments.

■ Adjusting the Tuning setting: Method 1

Operation Guide: SETTINGS (page 14~15)

Press and hold the METRONOME and SOUND SELECT buttons, then enter the desired pitch using the number keys indicated below.

* The keyboard pitch can be adjusted within the range of 427 - 453 Hz.

* To reset the pitch to 440.0Hz, press the Reset key indicated below.

■ Adjusting the Tuning setting: Method 2

Operation Guide: SETTINGS (page 14~15)

Press and hold the METRONOME and SOUND SELECT buttons, then press the keys assigned +/- to lower or raise the keyboard pitch in 0.5 Hz steps.

6 Transpose

The Key Transpose setting allows the pitch of the KDP120/KDP75 digital piano keyboard to be raised or lowered in semi-tone steps. This is particularly useful when accompanying instruments with different tones, or when a song learned in one key must be played in another key. When transposed, the song can be played in the original key, yet heard in a different key.

■ Adjusting the Transpose setting

Operation Guide: SETTINGS (page 14~15)

Press and hold the METRONOME and SOUND SELECT buttons, then press the keys assigned -/+ to lower or raise the keyboard pitch in semi-tone steps.

* The transpose setting can be adjusted within the range of -6 - +5 semi-tones.

* To disable/enable the transpose setting, press the key assigned to the "off/on" function.

7 Brilliance

The Brilliance setting allows the brightness of the KDP120/KDP75 digital piano's sound to be adjusted.

■ Adjusting the Brilliance setting

Operation Guide: SOUND (page 12~13)

Press and hold the SOUND SELECT button, then press the F#4 or G#4 key repeatedly to decrease or increase the brightness of the sound.

* The Brilliance setting can be adjusted within the range of -10~+10, with +10 being the brightest setting.

* To reset the Brilliance effect, press and hold the SOUND SELECT button, then press the C#4 key.

8 Virtual Technician (Smart Mode)

An experienced piano technician is essential to fully realise the potential of a fine acoustic piano. In addition to meticulously tuning each note, the technician also performs numerous regulation and voicing adjustments that allow the instrument to truly sing.

The KDP120/KDP75 digital piano's Virtual Technician simulates these refinements digitally, with ten preset configurations that intelligently adjust various characteristics of the grand piano sound to match different musical styles.

■ Virtual Technician type

Virtual Technician type	Description	Key
Normal (default)	The default piano sound without additional adjustments.	C6
Noiseless	A piano adjusted to minimise additional damper resonance.	D6
Deep Resonance	A piano adjusted to emphasise damper resonance.	E6
Light Resonance	A piano adjusted to reduce damper resonance.	F6
Soft	A piano adjusted by softening the hammers and increasing the touch weight of the keyboard in order to produce a softer tone that is suitable for slow, quiet pieces.	G6
Brilliant	A piano adjusted by hardening the hammers in order to produce a brighter tone for modern pieces.	A6
Clean	A piano adjusted by hardening the hammers and reducing the damper resonance.	C#6
Full	A piano adjusted to emphasise dynamics with a lightened keyboard touch and powerful damper resonance.	D#6
Dark	A piano adjusted by hardening the hammers and increasing the touch weight of the keyboard, in order to produce a dark, gloomy tone.	F#6
Rich	A piano adjusted by lightening the touch weight of the keyboard and increasing damper resonance.	G#6
Historical	A piano adjusted for romantic, classical music, with a bright, open tone.	A#6

■ Selecting the Virtual Technician type

Operation Guide: SOUND (page 12~13)

Press and hold the SOUND SELECT button, then press the key assigned to the desired Virtual Technician type.

■ Piano Remote

In addition to changing the piano's sound by selecting different Virtual Technician presets, it is also possible to adjust individual characteristics using the PianoRemote app. This app gives the player full control over every aspect of the piano's configuration, allowing precise adjustments to be made to voicing, damper resonance and various other acoustic characteristics, from a convenient touchscreen interface.

9 Spatial Headphone Sound

Spatial Headphone Sound is a special feature of the KDP120/KDP75 digital piano that enhances the depth and realism of the acoustic piano sound when listening through headphones or earphones.

The Spatial Headphone Sound setting allows the player to select from one of three different acoustic presets that adjust the spatial positioning of the sound, while also helping to reduce auditory fatigue when using earphones or headphones for extended periods of time.

■ Spatial Headphone Sound type

Spatial Headphone Sound type	Description	Key
Off	Disable the Spatial Headphone Sound feature.	C#7
Forward	Front focused, somewhat narrow spatial positioning.	F#7
Normal (default)	Naturally balanced spatial positioning that is neither forward nor wide.	G#7
Wide	Wide, very open spatial positioning.	A#7

■ Setting the Spatial Headphone Sound system

Operation Guide: SOUND (page 12~13)

Press and hold the SOUND SELECT button, then press the key assigned to the desired Spatial Headphone Sound type.

10 Phones Type

The Phones Type setting optimises the sound of the KDP120/KDP75 digital piano when listening through different types of headphones or earphones.

* This setting does not affect the speaker sound.

■ Phones type

Phones type	Description	Key
Normal (default)	Disables headphone optimisation.	C7
Open	Optimises the sound for open type headphones.	D7
Semi-open	Optimises the sound for semi-open type headphones.	E7
Closed	Optimises the sound for closed type headphones.	F7
Inner-ear	Optimises the sound for inner-ear type headphones.	G7
Canal	Optimises the sound for canal-type headphones	A7

■ Phones Type setting

Operation Guide: SOUND (page 12~13)

Press and hold the SOUND SELECT button, then press the key assigned to the desired Phones type.

Auto Power Off

The KDP120/KDP75 digital piano features a power saving function that can be used to automatically turn off the instrument after a specified period of inactivity.

■ Auto Power Off settings

Auto Power Off	Explanation	Key
Off	The Auto Power Off function is disabled.	G7
15 min.	The instrument will turn off automatically after 15 minutes of inactivity.	A7
60 min.	The instrument will turn off automatically after 60 minutes of inactivity.	B7
120 min.	The instrument will turn off automatically after 120 minutes of inactivity.	C8

■ Selecting the Auto Power Off setting

Operation Guide: SETTINGS (page 14~15)

Press and hold the METRONOME and SOUND SELECT buttons simultaneously, then press the key assigned to the desired Auto Power Off setting.

* The Auto Power Off setting will be stored automatically, and recalled every time the instrument is turned on.

Bluetooth® MIDI (KDP120 only)

The Bluetooth MIDI setting is used to enable/disable the KDP120 digital piano's Bluetooth MIDI function. When enabled, the KDP120 digital piano can be connected to smart phones, tablets, and other smart devices to facilitate wireless MIDI communication, allowing a wide range of music-related apps to be enjoyed using the instrument.

* Availability of Bluetooth function dependent on market location.

■ Bluetooth MIDI settings

Bluetooth MIDI	Description	Key
Off	Disables the instrument's Bluetooth MIDI function.	G#2
On (default)	Enables the instrument's Bluetooth MIDI function.	A#2

■ Enabling/disabling Bluetooth MIDI

Operation Guide: SETTINGS (page 14~15)

Press and hold the METRONOME and SOUND SELECT buttons, then press the G#2 key to disable Bluetooth MIDI, or the A#2 key to enable Bluetooth MIDI.

■ Connecting the KDP120 digital piano to a smart device using Bluetooth MIDI

After enabling the Bluetooth MIDI function of the KDP120 digital piano, enable Bluetooth communications on the smart device. After a few moments the KDP120 digital piano should appear in the app's device list. Tap the KDP120 entry to connect the instrument to the smart device. It should now be possible for MIDI apps to communicate with the KDP120 digital piano.

* When the KDP120 digital piano is connected to a smart device via Bluetooth MIDI, the USB MIDI connector will be disabled.

* Please check for Bluetooth MIDI compatibility with the smart device manufacturer and app developer.

* For a list of potential issues and recommended solutions when using Bluetooth communications, please refer to page 44 of this owner's manual.

* For more detailed instructions regarding Bluetooth pairing, please refer to the Bluetooth support pages of the Kawai Global website:

<http://www.kawai-global.com/support/bluetooth/>

Information about Bluetooth® (KDP120 only)

Please refer to the following information about Bluetooth.

■ About Bluetooth

- The Bluetooth® word mark and logos are registered trademarks owned by the Bluetooth SIG, Inc. and any use of such marks by Kawai Musical Instruments Mfg. Co., Ltd. is under license.
- Frequency Band of Radio: 2400~2483.5 MHz Maximum Transmit Power: 2.5 mW (Bluetooth Low Energy), 4.5mW (A2DP)
- Availability of Bluetooth function dependent on market location.

■ For USA, Canada

It is strictly forbidden to use antenna except designated.
This equipment must not be co-located or operated in conjunction with any other antenna or transmitter.

■ For Canada

- This device complies with Industry Canada's licence-exempt RSSs. Operation is subject to the following two conditions:
(1) This device may not cause interference; and
(2) This device must accept any interference, including interference that may cause undesired operation of the device.
- Le présent appareil est conforme aux CNR d'Industrie Canada applicables aux appareils radio exempts de licence. L'exploitation est autorisée aux deux conditions suivantes :
(1) l'appareil ne doit pas produire de brouillage;
(2) l'utilisateur de l'appareil doit accepter tout brouillage radioélectrique subi, même si le brouillage est susceptible d'en compromettre le fonctionnement.

■ For South Africa



■ For Argentina

Marca : KAWAI, Bluegiga
Modelo : MBH7BLZ07, WT32i



■ For Korea

- 해당 무선설비는 전파혼신 가능성이 있으므로 인명안전과 관련된 서비스는 할 수 없습니다
- B 급 기기 (가정용 방송통신기자재) 이 기기는 가정용 (B 급) 전자파적합기기로서 주로 가정에서 사용하는 것을 목적으로 하며, 모든 지역에서 사용할 수 있습니다.
- 모델명 MBH7BLZ07 WT32i-A
- 인증을받은 상표 이름제조사 Kawai Musical Instruments Manufacturing Co., Ltd. Bluegiga Technologies Oy
- 원산지 일본 핀란드
- 기자재 명칭 정소출력 무선기기 (무선데이터통신시스템용 무선기기)
- 제조년 월 제품에 붙어있는 라벨을 확인하시기 바랍니다.

■ For Mexico

PIANO DIGITAL
MARCA : KAWAI
MODELO : MBH7BLZ07, RCPKAMB16-1764
: WT32i, RCPKAWT17-1556



La operación de este equipo está sujeta a las siguientes dos condiciones:

- (1) es posible que este equipo o dispositivo no cause interferencia perjudicial
- (2) este equipo o dispositivo debe aceptar cualquier interferencia,

■ For Brazil

Este equipamento opera em caráter secundário, isto é, não tem direito a proteção contra interferência prejudicial, mesmo de estações do mesmo tipo e não pode causar interferência a sistemas operando em caráter primário. Para consultas, visite: www.anatel.gov.br



04349-16-10021

02414-18-01395

■ For Taiwan

第十二條 經型式認證合格之低功率射頻電機，非經許可，公司、商號或使用者均不得擅自變更頻率、加大功率或變更原設計之特性及功能。
第十四條 低功率射頻電機之使用不得影響飛航安全及干擾合法通信；經發現有干擾現象時，應立即停用，並改善至無干擾時方得繼續使用。前項合法通信，指依電信法規定作業之無線電通信。低功率射頻電機須忍受合法通信或工業、科學及醫療用電波輻射性電機設備之干擾。

Connecting to Other Devices

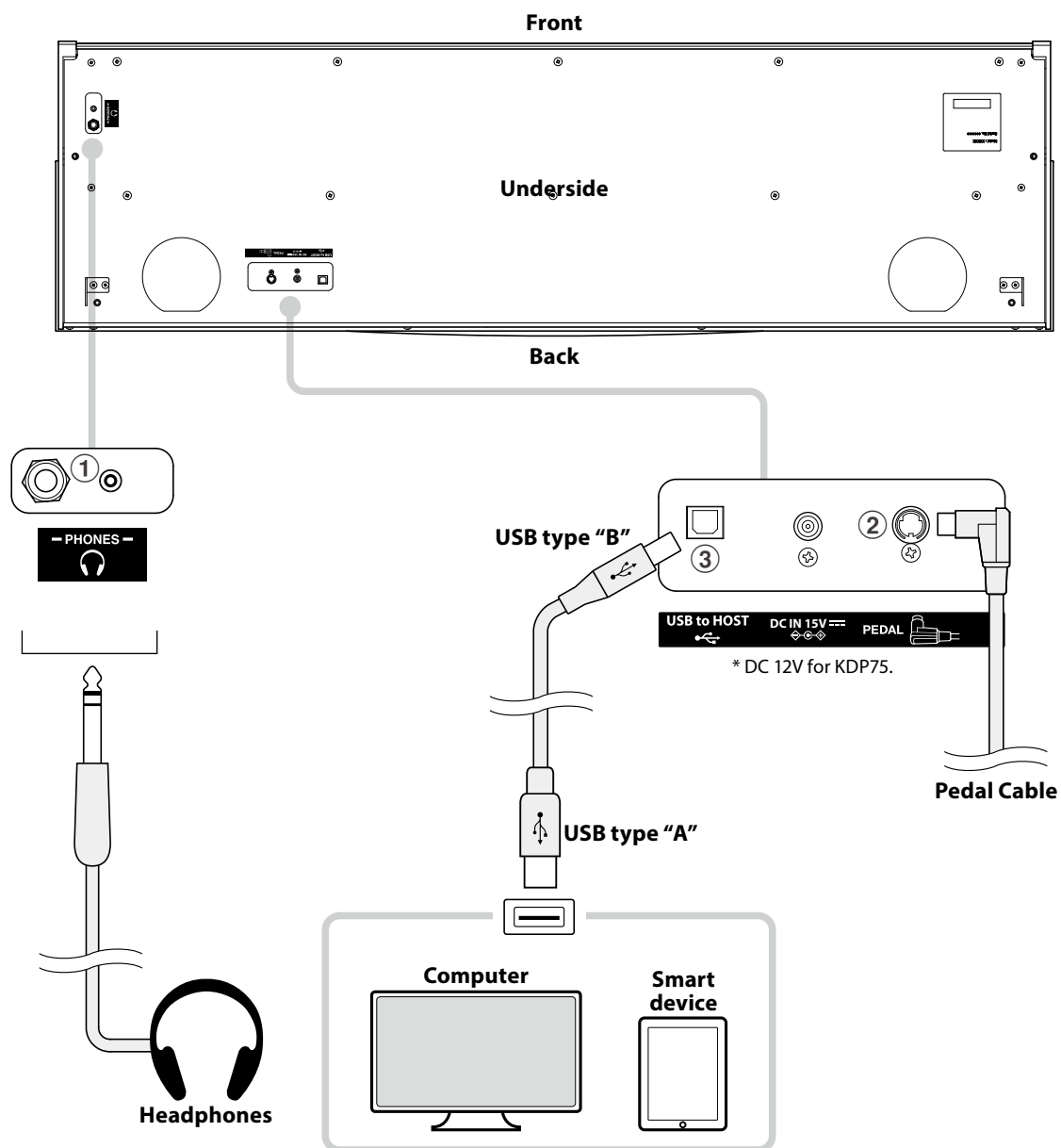

① PHONES jacks (1/4" & 1/8" phone jacks)

These jacks are used to connect stereo headphones to the KDP120/KDP75 digital piano. Headphones can be connected and used simultaneously. When a pair of headphones is connected, sound will not be produced by the speakers.

② PEDAL connector

This connector is used to connect the pedal board to the KDP120/KDP75 digital piano (see page 48).

③ USB to Host port ("B" type)

This port is used to connect the KDP120/KDP75 digital piano to a computer using an inexpensive USB cable. When connected, the instrument can be used as a standard MIDI device, allowing it to send and receive MIDI data. Connect a "B" type USB connector to the instrument, and an "A" type USB connector to the computer.

If there is no USB port of terminal A, a conversion adapter is required separately for connection.



Before connecting the KDP120/KDP75 digital piano to other devices, ensure that the power to both the instrument and the other device is turned off.

USB MIDI (USB to Host connector)

The KDP120/KDP75 digital piano features a “USB to Host” type connector, allowing the instrument to be connected to a computer using an inexpensive USB cable and utilised as a MIDI device. Depending on the type of computer and operating system installed, additional driver software may be required for USB MIDI communication to function correctly.

For more information regarding the USB MIDI driver, please visit the following website:

<https://www.kawai-global.com/support/downloads/>

■ USB MIDI information

- Ensure that the instrument is turned OFF before attempting to connect the USB MIDI cable.
- When connecting the instrument to a computer using the USB MIDI port, there may be a short delay before communications begin.
- If the instrument is connected to a computer via a USB hub and USB MIDI communication becomes unreliable/unstable, please connect the USB MIDI cable directly to the one of the computer’s USB ports.
- Disconnecting the USB MIDI cable suddenly, or turning the instrument on/off while using USB MIDI may cause computer instability in the following situations:
 - while installing the USB MIDI driver
 - while starting up the computer
 - while MIDI applications are performing tasks
 - while the computer is in energy saver mode
- If there are any further problems experienced with USB MIDI communication while the instrument is connected, please double-check all connections and relevant MIDI settings in the computer’s operating system.

Troubleshooting

	Problem	Possible Cause and Solution	Page no.
Power	The instrument does not turn on.	Check that the power cable is firmly attached to the instrument, and connected to an AC outlet.	p. 11
	The instrument turns itself off after a period of inactivity.	Check that the "Auto Power Off" function is not enabled.	p. 39
Sound	The instrument is turned on, however no sound is produced when the keys are played.	Check that the MASTER VOLUME slider is not set to the lowest position.	p. 11
		Check that a pair of headphones (or headphone adaptor plug) are not connected to the PHONES jack.	p. 11
		Check that Local Control is enabled in the MIDI Settings menu.	"MIDI Settings Manual" p. 5
Sound	The sound distorts when playing at very loud volume levels.	Check that the MASTER VOLUME slider is set to an appropriate level, reducing the volume if excessive distortion is heard.	p. 11
	Strange sounds or noises are heard when playing with piano sounds.	<p>The KDP120/KDP75 digital piano attempts to reproduce the rich variety of tones created by an acoustic grand piano as accurately as possible. This includes damper resonances and other subtle effects that contribute to the overall piano playing experience.</p> <p>While these additional effects are intended to enhance the realism of the instrument, it is possible to reduce their prominence, or disable them altogether using the sound settings.</p>	p.33 p.34
Pedals	The pedals are unreliable or do not function at all.	Check that the pedal cable is firmly connected to the instrument.	p. 48
	When depressing a pedal, the pedal board flexes and is not firm.	Check that the pedal support bolt is fully extended.	p. 48
	The top 18 notes of the keyboard sustain for longer than neighbouring notes, even when the damper pedal is not pressed.	This is the correct behaviour, and intended to reproduce the undamped notes (typically the top two octaves) of an acoustic grand piano.	—
USB MIDI, Bluetooth® MIDI	The instrument is connected to the computer using a USB cable, however the software does not respond to key presses.	Check that a USB MIDI driver is installed on the computer.	p. 43
		Check that "USB Audio Device" or "KAWAI USB MIDI" is selected in the software's input/output device settings.	p. 43
		Check that the instrument is not connected to a smart device using Bluetooth MIDI. (KDP120 only)	p. 40
	The instrument cannot connect to the smart device/app via Bluetooth. (KDP120 only)	<p>Check that the instrument's Bluetooth MIDI function is turned On.</p> <p>Ensure that the mobile device's Bluetooth function is turned On.</p> <p>Try deleting the instrument's Bluetooth connection using the mobile device's "Forget Device" function.</p> <p>Try turning the instrument Off and then On, and/or restarting the mobile device.</p>	p. 40

Assembly Instructions



Please read these assembly instructions thoroughly before attempting to assemble the KDP120/KDP75 digital piano.

Please ensure that two or more people work on assembling the KDP120/KDP75 digital piano, especially when lifting the main body of the instrument onto the stand in step 3.

■ Included parts

Before attempting to assemble the KDP120/KDP75 digital piano, ensure that all parts below are included. A Phillips-head screwdriver (not included) will also be required in order to assemble the instrument.

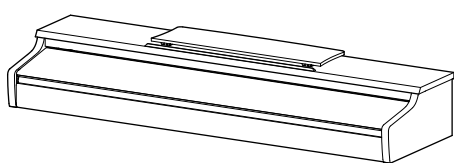

① Main body

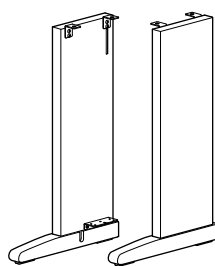

② Side panel
(left, right)

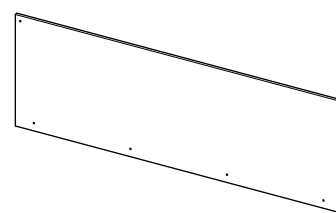

③ Back board

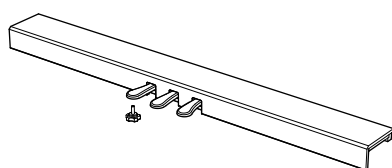

④ Pedal board
Pedal support bolt

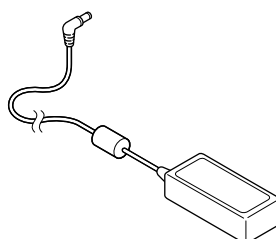

⑤ AC/DC Adaptor

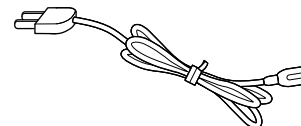

⑥ Power cable

Screw set

⑦ Screw (with flat washer and spring washer) x 4



⑧ Tapping screw (long, black, 4 x 30 mm) x 2 *

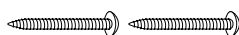

⑨ Tapping screw (short, black, 4 x 20 mm) x 4 *

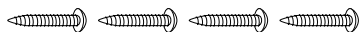

⑩ Tapping screw (silver, 4 x 16 mm) x 4



* For White finished instruments, black screws will be replaced with silver screws.

* ⑩ Silver screws are provided in a separate bag.

⑪ Headphone hook set x 1

Headphone hook x 1



Mounting screw x 2



Assembly Instructions

1. Assembling the side panels ②, and pedal board ④

Unfasten and extend the pedal connection cable attached to the bottom of the pedal board ④.

Attach the pedal board ④ to the left and right side panels ② using the alignment screws located on either end of the pedal board. Ensure that the correct side panel is used for the left and right side.

Ensure that the pedal board and side panels make close contact, and that there are no large gaps between the assembled parts.

Insert the four short silver tapping screws ⑩ into the holes as shown, and securely fasten the pedal board to the and left and right side panels.

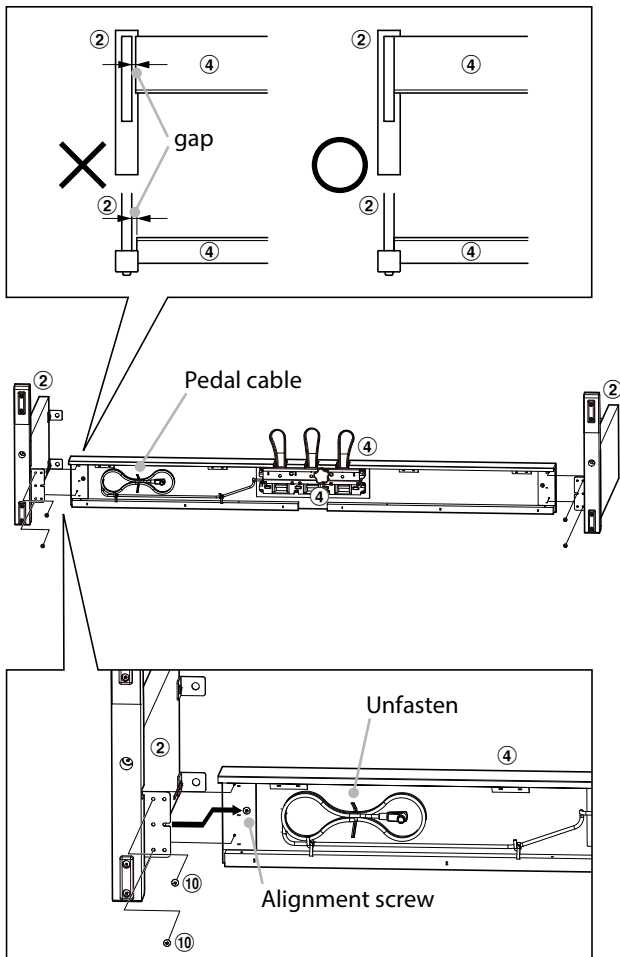

2. Attaching the back board ③

Allow the assembled pedal board and side panels to stand upright (vertically) on the floor.

* Ensure that the adjustor bolt is attached to the pedal board.

Temporarily fix the back board ③ to the left and right side panels using the two long black tapping screws ⑧*, leaving a tightening allowance of approximately 1-2 mm.

Then attach the bottom of the back board to the pedal board using the four short black tapping screws ⑨*.

* For White finished instruments, black screws will be replaced with silver screws.

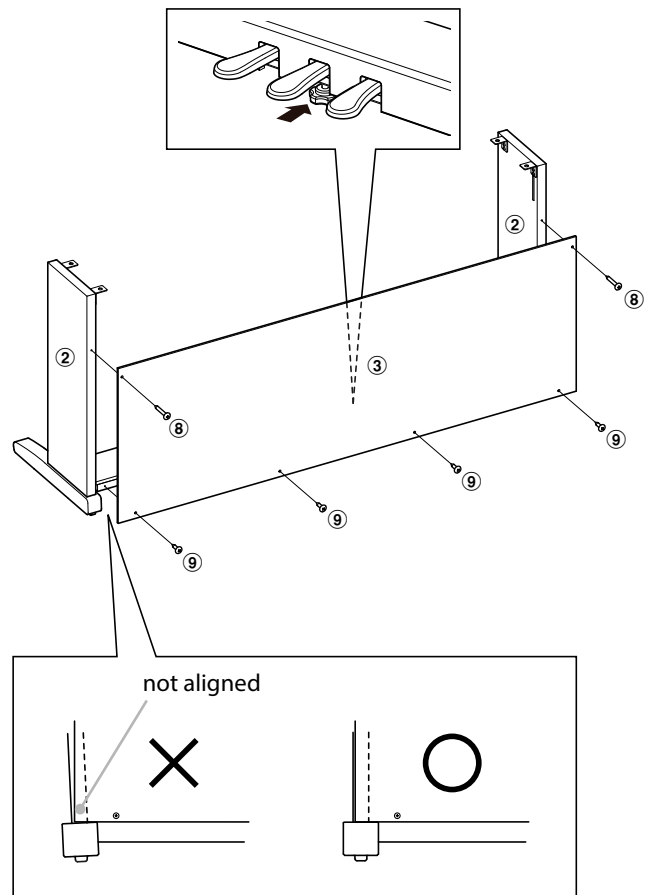

3. Mounting the main body ①

 **Ensure that two or more people undertake the following step of the assembly process.**

Lift the main body ① and carefully place it onto the stand.

Position the main body towards the front of the stand, so that the metal fitting holes are visible when viewed from above.

Gently slide the main body backwards until the base engages with the fixings inside the side panels and locks into place.

 **When lifting the main body onto the stand, be careful not to catch/trap hands and fingers.**

Secure the main body to the stand from below, using the four screws (with the flat washer and spring washer) ⑦.

 **Tighten all screws securely to ensure that the main body is firmly attached to the stand. Failing to do so may result in serious injury.**

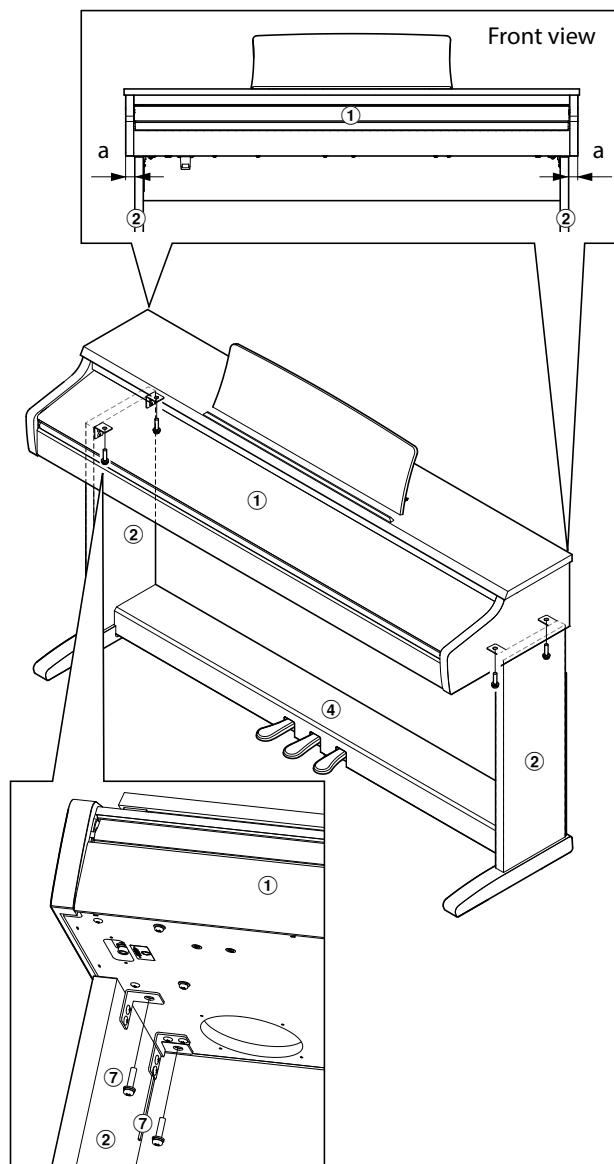
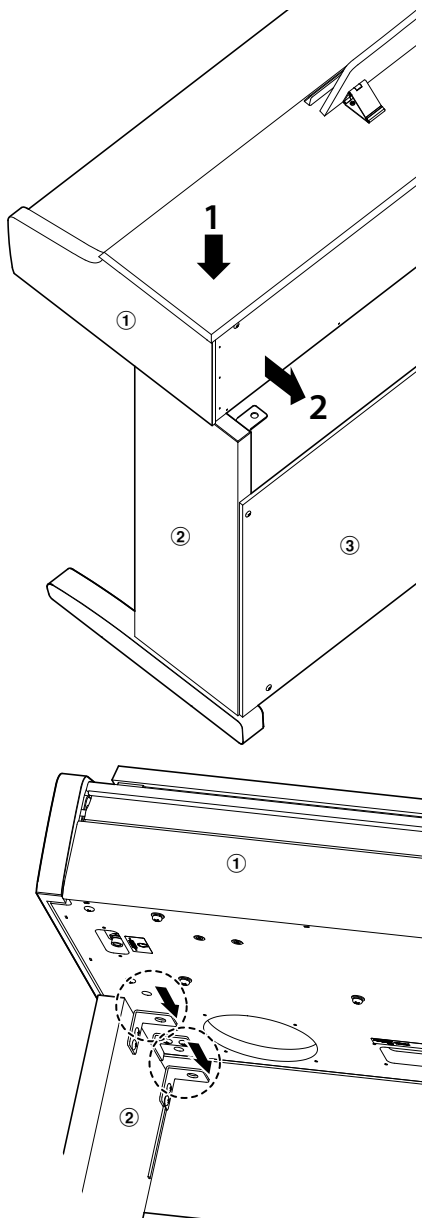

Assembly Instructions

4. Connecting the pedal cable and AC/DC adaptor

Connect the pedal cable to the PEDAL terminal located on the underside of the main body.

Connect the AC/DC adaptor ⑤ to the DC IN terminal.

Use the binders to fix the cables in place.

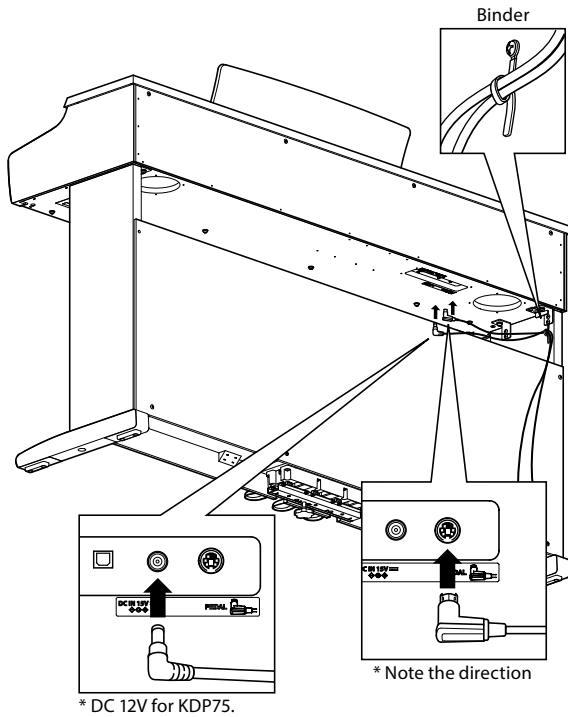

6. Adjusting the pedal support bolt

Turn the pedal support bolt anti-clockwise until it makes contact with the floor and supports the pedals firmly.

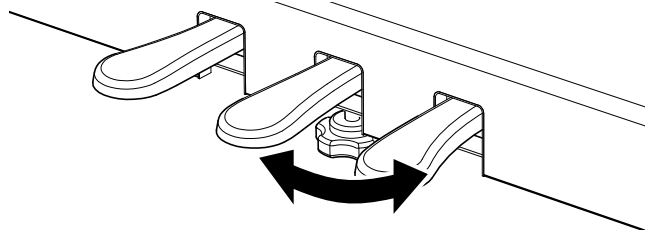

When moving the instrument, always adjust or remove the pedal support bolt, then readjust when the instrument is in its new position.

5. Attaching the headphone hook (optional)

If desired, attach the headphone hook to the underside of the main body using the two tapping screws provided.

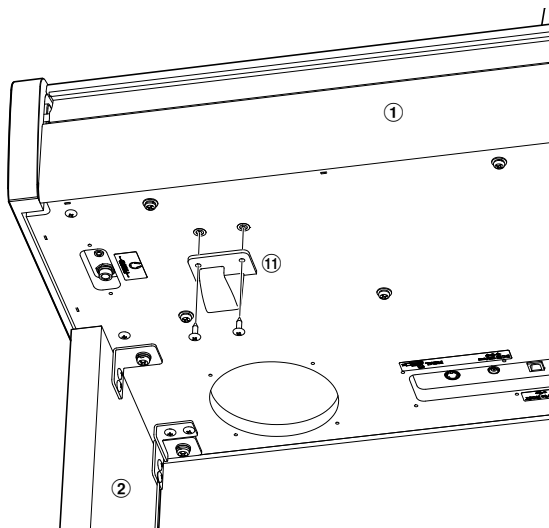

Demo Song List

Key	No.	Sound Name (Song Title)	Composer
A0	1	Concert Grand (La Campanella)	Liszt
B0	2	Studio Grand (Original)	Kawai
C1	3	Mellow Grand (Sonata No.30 Op.109)	Beethoven
D1	4	Modern Piano (Original)	Kawai
E1	5	Classic E.Piano (Original)	
F1	6	Modern E.Piano (Original)	
G1	7	Jazz Organ (Original)	
A1	8	Church Organ (Chorale Prelude "Wachet auf, ruft uns die Stimme.")	Bach
B1	9	Harpsichord (French Suite No.6)	Kawai
C2	10	Vibraphone (Original)	
D2	11	String Ensemble (Le quattro stagioni: la "Primavera")	Vivaldi
E2	12	Slow Strings (Original)	Kawai
F2	13	Choir (Londonderry Air)	Irish folk song
G2	14	New Age Pad (Original)	Kawai
A2	15	Atmosphere (Original)	

Concert Magic Song List

Key	No.	Song Name	Composer	Type
Children's Songs				
A0	1	Twinkle, Twinkle, Little Star	French folk song	MP
A#0	2	I'm A Little Teapot	Traditional	MP
B0	3	Mary Had A Little Lamb	American folk song	MP
C1	4	London Bridge	Traditional	MP
C#1	5	Row, Row, Row Your Boat	American folk song	MP
D1	6	Frère Jacques	French folk song	MP
D#1	7	Old MacDonald Had A Farm	American folk song	MP

Christmas Songs				
E1	8	Hark The Herald Angels Sing	Mendelssohn	MP
F1	9	Jingle Bells	Traditional	MP
F#1	10	Deck The Halls	Welsh Air	MP
G1	11	O Come All Ye Faithful	J.Reading	MP
G#1	12	Joy To The World	Traditional	MP
A1	13	Silent Night	Traditional	MP
A#1	14	We Wish You A Merry Christmas	British folk song	MP

American Classics				
B1	15	Battle Hymn Of The Republic	Traditional	MP
C2	16	Yankee Doodle	American folk song	MP
C#2	17	Londonderry Air	Irish folk song	EB
D2	18	Clementine	American folk song	MP
D#2	19	Auld Lang Syne	Scottish folk song	MP
E2	20	Oh Susanna	S.C.Foster	SK
F2	21	The Camptown Races	S.C.Foster	MP
F#2	22	When The Saints Go Marching In	American folk song	EB
G2	23	The Entertainer	S.Joplin	SK

Key	No.	Song Name	Composer	Type
Classical Selections				
G#2	24	William Tell Overture	Rossini	SK
A2	25	Andante from Symphony No.94	Haydn	MP
A#2	26	Für Elise	Beethoven	EB
B2	27	Clair De Lune	Debussy	SK
C3	28	Skater's Waltz	E.Waldteufel	SK
C#3	29	Blue Danube Waltz	Strauss	SK
D3	30	Gavotte	Gossec	SK
D#3	31	Waltz Of The Flowers	Tchaikovsky	SK

Special Occasions				
E3	32	Bridal Chorus	Wagner	MP
F3	33	Wedding March	Mendelssohn	SK
F#3	34	Pomp And Circumstance	Elgar	SK

International Songs				
G3	35	When Irish Eyes Are Smiling	E.R.Ball	EB
G#3	36	Chiapanecas	Mexican folk song	SK
A3	37	Santa Lucia	Naplish folk song	SK
A#3	38	Funiculi Funiculà	L.Denza	SK
B3	39	Romance De L'amour	Spanish folk song	EB
C4	40	My Wild Irish Rose	Chauncy Alcote	EB

Lesson Function Song Lists

No.	Alfred's Basic Piano Library Lesson Book Level 1A
1	Right & Left
2	Left & Right
3	Merrily We Roll Along/O'er the Deep Blue Sea
4	Hand-Bells
5	Jolly Old Saint Nicholas
6	Old MacDonald
7	Batter Up!
8	My Clever Pup
9	The Zoo
10	Playing in a New Position
11	Sailing
12	Skating
13	Wishing Well
14	Rain, Rain!
15	A Happy Song
16	Position C
17	A Happy Song
18	See-Saws
19	Just a Second!
20	Balloons
21	Who's on Third?
22	Mexican Hat Dance
23	Rock Song
24	Rockets
25	Sea Divers
26	Play a Fourth
27	July the Fourth!
28	Old Uncle Bill
29	Love Somebody
30	My Fifth
31	The Donkey
32	Position G
33	Jingle Bells!
34	Willie & Tillie
35	A Friend Like You
36	My Robot
37	Rockin' Tune
38	Indian Song
39	Raindrops
40	It's Halloween!
41	Horse Sense

No.	Alfred's Basic Piano Library Lesson Book Level 1B
1	Step Right Up!
2	The Carousel
3	Hail to Thee, America!
4	Brother John
5	Good Sounds
6	The Cuckoo
7	Money Can't Buy Ev'rything!
8	Ping-Pong
9	Grandpa's Clock
10	When the Saints Go Marching In
11	G's in the "BAG"
12	Join the Fun
13	Oom-Pa-pa!
14	The Clown
15	Thumbs on C!
16	Waltz Time
17	Good King Wenceslas
18	The Rainbow
19	Yankee Doodle
20	The Windmill
21	Indians
22	New Position G
23	Pedal Play
24	Harp Song
25	Concert Time
26	Music Box Rock
27	A Cowboy's Song
28	The Magic Man
29	The Greatest Show on Earth!
30	The Whirlwind
31	The Planets
32	C Major Scale Piece
33	G Major Scale Piece
34	Carol in G Major
35	The Same Carol in C Major
36	French Lullaby
37	Sonatina
38	When Our Band Goes Marching By!

No.	Burgmüller 25 (25 Etudes Faciles, Opus 100)
1	La candeur
2	Arabesque
3	Pastorale
4	Petite réunion
5	Innocence
6	Progrès
7	Courant Limpide
8	La gracieuse
9	La chasse
10	Tendre fleur
11	La bergeronnette
12	Adieu
13	Consolation
14	La styrienne
15	Ballade
16	Douce plainte
17	Babillarde
18	Inquiétude
19	Ave Maria
20	Tarentelle
21	Harmonie des anges
22	Barcarolle
23	Retour
24	L'hirondelle
25	La chevaleresque

Czerny 30 (Etudes de Mécanisme, Opus 849)	
No. 1 to No. 30	
<hr/>	
Beyer 106	
No. 1 (1-1 to 1-12)	
No. 2 (2-1 to 2-8)	
No. 3 to No. 106	

■ Lesson Function song book availability

Alfred's Basic Piano Library, Burgmüller: *Etudes Faciles*, Czerny: *Etudes de Mécanisme*, and Beyer lesson song books are sold separately. Please check your local dealer for more information. Alfred's international offices may also be contacted directly:

USA / Canada
 Alfred Music Publishing
 PO Box 10003
 Van Nuys, CA 91410
 Tel: +1 (800) 292-6122
 Email: sales@alfred.com
 Website: <http://www.alfred.com>

Australia
 Alfred Publishing Australia
 PO Box 2355
 Taren Point NSW 2229
 Tel: +61 (02) 9524 0033
 Email: sales@alfredpub.com.au

Information about Adaptor Specifications

This adapter specification table conforms to the requirements of EU Commission Regulation (EU) 2019/1782.

	Adaptor Type			
	PS-129	PS-154	PS-241	PS-242
Manufacturer's trademark	KAWAI	KAWAI	KAWAI	KAWAI
Model identifier	PS-129	PS-154	PS-241	PS-242
Input voltage	230 V	230 V	230 V	230 V
Input AC frequency	50 Hz	50 Hz	50 Hz	50 Hz
Output voltage	12.0 V	15.0 V	24.0 V	24.0 V
Output current	2.0 A	4.0 A	6.2 A	5.0 A
Output power	24.0 W	60.0 W	150.0 W	120.0 W
Average active efficiency	90.38%	88.80%	90.41%	91.55%
Efficiency at low load (10%)	85.71%	84.33%	78.62%	88.84%
No-load power consumption	0.061 W	0.082 W	0.135 W	0.020 W

EU Declaration of Conformity

BG	ОПРОСТЕНА ЕС ДЕКЛАРАЦИЯ ЗА СЪОТВЕТСТВИЕ
Bulgarian	C настоящото Kawai Европа GmbH декларира, че този тип радиосъоръжение [KDP120/KDP75] е в съответствие с Директива 2014/53/ЕО. Цялостният текст на ЕС декларацията за съответствие може да се намери на следния интернет адрес:
ES	DECLARACIÓN UE DE CONFORMIDAD SIMPLIFICADA
Spanish	Por la presente, Kawai Europa GmbH declara que el tipo de equipo radioeléctrico [KDP120/KDP75] es conforme con la Directiva 2014/53/UE. El texto completo de la declaración UE de conformidad está disponible en la dirección Internet siguiente:
CS	ZJEDNODUŠENÉ EU PROHLÁŠENÍ O SHODĚ
Czech	Tímto Kawai Europa GmbH prohlašuje, že typ rádiového zařízení [KDP120/KDP75] je v souladu se směrnicí 2014/53/EU. Úplné znění EU prohlášení o shodě je k dispozici na této internetové adrese:
DA	FORENKLET EU-OVERENSSTEMMELSESERKLÆRING
Danish	Hermed erklærer Kawai Europa GmbH, at radioudstyrstypen [KDP120/KDP75] er i overensstemmelse med direktiv 2014/53/EU. EU-overensstemmelseserklæringens fulde tekst kan findes på følgende internetadresse:
DE	VEREINFACHTE EU-KONFORMITÄTSERKLÄRUNG
German	Hiermit erklärt Kawai Europa GmbH, dass der Funkanlagentyp [KDP120/KDP75] der Richtlinie 2014/53/EU entspricht. Der vollständige Text der EU-Konformitätserklärung ist unter der folgenden Internetadresse verfügbar:
ET	LIHTSUSTATUD ELI VASTAVUSDEKLARATSIOON
Estonian	Käesolevaga deklareerib Kawai Europa GmbH, et käesolev raadioseadme tüüp [KDP120/KDP75] vastab direktiivi 2014/53/EL nõuetele. ELi vastavusdeklaratsiooni täielik tekst on kättesaadav järgmisel internetiaadressil:
EL	ΑΠΛΟΥΣΤΕΥΜΕΝΗ ΔΗΛΩΣΗ ΣΥΜΜΟΡΦΩΣΗΣ ΕΕ
Greek	Με την παρούσα ο/η Kawai Europa GmbH, δηλώνει ότι ο ραδιοεξοπλισμός [KDP120/KDP75] πληροί την οδηγία 2014/53/ΕΕ. Το πλήρες κείμενο της δήλωσης συμμόρφωσης ΕΕ διατίθεται στην ακόλουθη ιστοσελίδα στο διαδίκτυο:
EN	SIMPLIFIED EU DECLARATION OF CONFORMITY
English	Hereby, Kawai Europa GmbH declares that the radio equipment type [KDP120/KDP75] is in compliance with Directive 2014/53/EU. The full text of the EU declaration of conformity is available at the following internet address:
FR	DECLARATION UE DE CONFORMITE SIMPLIFIEE
French	Le soussigné, Kawai Europa GmbH, déclare que l'équipement radioélectrique du type [KDP120/KDP75] est conforme à la directive 2014/53/UE. Le texte complet de la déclaration UE de conformité est disponible à l'adresse internet suivante:
HR	POJEDNOSTAVLJENA EU IZJAVA O SUKLADNOSTI
Croatian	Kawai Europa GmbH ovime izjavljuje da je radijska oprema tipa [KDP120/KDP75] u skladu s Direktivom 2014/53/EU. Cjeloviti tekst EU izjave o sukladnosti dostupan je na sljedećoj internetskoj adresi:
IT	DICHIARAZIONE DI CONFORMITÀ UE SEMPLIFICATA
Italian	Il fabbricante, Kawai Europa GmbH, dichiara che il tipo di apparecchiatura radio [KDP120/KDP75] è conforme alla direttiva 2014/53/UE. Il testo completo della dichiarazione di conformità UE è disponibile al seguente indirizzo Internet:
LV	VIENKĀRŠOTA ES ATBILSTĪBAS DEKLARĀCIJA
Latvian	Ar šo Kawai Europa GmbH deklarē, ka radioiekārtā [KDP120/KDP75] atbilst Direktīvai 2014/53/ES. Pilns ES atbilstības deklarācijas teksts ir pieejams šādā interneta vietnē:
LT	SUPAPRASTINTA ES ATITIKTIES DEKLARACIJA
Lithuanian	Aš, Kawai Europa GmbH, patvirtinu, kad radijo įrenginių tipas [KDP120/KDP75] atitinka Direktyvą 2014/53/ES. Visas ES atitikties deklaracijos tekstas prieinamas šiuo interneto adresu:
HU	EGYSZERŰSÍTETT EU-MEGFELELŐSÉGI NYILATKOZAT
Hungarian	Kawai Europa GmbH igazolja, hogy a [KDP120/KDP75] típusú rádióberendezés megfelel a 2014/53/EU irányelvnek. Az EU-megfelelőségi nyilatkozat teljes szövege elérhető a következő internetes címen:
MT	DIKJARAZZJONI SSIMPLIFIKATA TA' KONFORMITÀ TAL-UE
Maltese	B'dan, Kawai Europa GmbH, niddikjara li dan it-tip ta' tagħmir tar-radju [KDP120/KDP75] huwa konformi mad-Direttiva 2014/53/UE. It-test kollu tad-dikjarazzjoni ta' konformità tal-UE huwa disponibbli f'dan l-indirizz tal-Internet li ġej:
NL	VEREENVOUDIGDE EU-CONFORMITEITSVERKLARING
Dutch	Hierbij verklaar ik, Kawai Europa GmbH, dat het type radioapparatuur [KDP120/KDP75] conform is met Richtlijn 2014/53/EU. De volledige tekst van de EU-conformiteitsverklaring kan worden geraadpleegd op het volgende internetadres:
PL	UPROSZCZONA DEKLARACJA ZGODNOŚCI UE
Polish	Kawai Europa GmbH niniejszym oświadcza, że typ urządzenia radiowego [KDP120/KDP75] jest zgodny z dyrektywą 2014/53/UE. Pełny tekst deklaracji zgodności UE jest dostępny pod następującym adresem internetowym:
PT	DECLARAÇÃO UE DE CONFORMIDADE SIMPLIFICADA
Portuguese	O(a) abaixo assinado(a) Kawai Europa GmbH declara que o presente tipo de equipamento de rádio [KDP120/KDP75] está em conformidade com a Diretiva 2014/53/UE. O texto integral da declaração de conformidade está disponível no seguinte endereço de Internet:
RO	DECLARAȚIA UE DE CONFORMITATE SIMPLIFICATĂ
Romanian	Prin prezenta, Kawai Europa GmbH declară că tipul de echipamente radio [KDP120/KDP75] este în conformitate cu Directiva 2014/53/UE. Textul integral al declarației UE de conformitate este disponibil la următoarea adresă internet:
SK	ZJEDNODUŠENÉ EÚ VYHLÁSENIE O ZHODE
Slovak	Kawai Europa GmbH týmto vyhlasuje, že rádiové zariadenie typu [KDP120/KDP75] je v súlade so smernicou 2014/53/EÚ. Úplné EÚ vyhlásenie o zhode je k dispozícii na tejto internetovej adrese:
SL	POENOSTAVLJENA IZJAVA EU O SKLADNOSTI
Slovenian	Kawai Europa GmbH potrjuje, da je tip radijske opreme [KDP120/KDP75] skladen z Direktivo 2014/53/EU. Celotno besedilo izjave EU o skladnosti je na voljo na naslednjem spletnem naslovu:
FI	YKSINKERTAISTETTU EU-VAATIMUSTENMUKAISUUSVAKUUTUS
Finnish	Kawai Europa GmbH vakuuttaa, että radiolaitetyypit [KDP120/KDP75] on direktiivin 2014/53/EU mukainen. EU-vaatimustenmukaisuusvakuutuksen täysimittainen teksti on saatavilla seuraavassa internetosoitteessa:
SV	FÖRENKLAD EU-FÖRSÄKRAN OM ÖVERENSSTÄMMELSE
Swedish	Härmed försäkras Kawai Europa GmbH att denna typ av radioutrustning [KDP120/KDP75] överensstämmer med direktiv 2014/53/EU. Den fullständiga texten till EU-försäkran om överensstämmelse finns på följande webbadress:
https://www.kawai-global.com/	

Specifications

	KDP120	KDP75
Keyboard	88 weighted keys Responsive Hammer Compact II (RHC II) action	88 weighted keys Responsive Hammer Compact (RHC) action
Sound Source	Harmonic Imaging™ (HI), 88-key piano sampling	
Internal Sounds	Concert Grand, Studio Grand, Mellow Grand, Modern Piano, Classic E.Piano, Modern E.Piano, Jazz Organ, Church Organ, Harpsichord, Vibraphone, String Ensemble, Slow Strings, Choir, New Age Pad, Atmosphere	
Polyphony	max. 192 notes	
Reverb	Room, Lounge, Small Hall, Concert Hall, Live Hall, Cathedral	
Internal Recorder	3 song recorder - approximately 10,000 note memory capacity	
Lesson Function	Alfred, Burgmüller, Czerny and Beyer lesson songs	
Metronome	Beat: 1/4, 2/4, 3/4, 4/4, 5/4, 3/8, 6/8 Tempo: 10-300 bpm	
Demo Songs	15 songs	
Keyboard Modes	Dual Mode (with adjustable volume balance) Four Hands Mode	
Virtual Technician	Smart Mode:	10 presets
	Advanced Mode: (adjustable via app)	Touch Curve, Damper Resonance, Hammer Delay, Topboard Simulation, Decay Time, Minimum Touch, Stretch Tuning, Temperament, Temperament Key, Half-Pedal Point, Soft Pedal Depth, Voicing, Release Time
Other Functions	Damper Resonance, Reverb, Touch, Low Volume Balance, Tuning, Transpose, Brilliance, Spatial Headphone Sound, Phones Type, Auto Power Off, Bluetooth MIDI (KDP120 only), Transmit Program Change Number, MIDI Channel, Local Control, Multi-timbral mode	
Bluetooth * (KDP120 only)	Bluetooth (Ver. 4.1; GATT compatible) Bluetooth Low Energy MIDI Specification compliant	
Pedals	Sustain (with half-pedal support), Soft, Sostenuto (GFPS)	Sustain (with half-pedal support), Soft, Sostenuto
Jacks	Headphones × 2, USB to HOST	
Speakers	12 cm × 2	(8 × 12) cm × 2
Output Power	20 W × 2	9 W × 2
Power Consumption	15 W	7 W
Key Cover	Sliding type	
Dimensions	1360 (W) × 405 (D) × 855 (H) mm (folding Music Rack)	
Weight	37 kg	36 kg

Specifications are subject to change without notice.

* Availability of Bluetooth function dependent on market location.

KAWAI

THE FUTURE OF THE PIANO

